

PZ 62E User Manual

E-500/E-501 Series Modular Piezo Controller

Release: 2.15.1 Date: 2013-07-11

This document describes the following products:

- E-500 and E-501 Chassis with Power Supply
- E-503, E-504, E-505, E-506, E-508 Amplifier Modules
- E-509 Sensor / Piezo Servo Control Modules
- E-515 and E-517 Display / Interface Modules



© Physik Instrumente (PI) GmbH & Co. KG
Auf der Römerstr. 1 · 76228 Karlsruhe, Germany
Tel. +49-721-4846-0 · Fax: +49-721-4846-1019
info@pi.ws · www.pi.ws

Table of Contents:

1.	About this Document.....	4
1.1.	Goal and Target Audience of this Manual.....	4
1.2.	Symbols and Typographic Conventions.....	4
1.3.	Other Applicable Documents	5
1.4.	Downloading Manuals.....	6
2.	Safety	7
2.1.	Intended Use	7
2.2.	General Safety Instructions	7
2.3.	Organizational Measures	8
3.	Introduction.....	9
3.1.	Model Survey.....	9
3.2.	Configuration Example	10
3.3.	Compatibility Note.....	11
3.4.	Signal Path Diagram.....	12
3.5.	Maximum Ratings.....	13
3.6.	Ambient Conditions and Classifications	13
4.	Handling	14
4.1.	Unpacking Checklist	14
4.2.	Safety Measures for Installation, Start-Up and Operation	14
4.3.	Power Connection	16
4.4.	First Electrical Checks	16
4.5.	Connecting Cables	16
4.6.	Starting Operation	17
4.6.1.	Analog Operation.....	17
4.6.2.	Computer Controlled Operation	17
5.	Module Description	18
5.1.	E-500.00 19" Chassis with Power Supply	18
5.1.1.	Specifications	18
5.1.2.	Dimensions.....	18
5.2.	E-501.00 9.5" Chassis with Power Supply	19
5.2.1.	Specifications	19
5.2.2.	Dimensions.....	19
5.3.	E-503 3-Channel Piezo Amplifier	20
5.3.1.	Front Panel Elements	20

5.3.2.	Operating Limits	21
5.3.3.	Specifications	22
5.3.4.	Pin Assignment.....	23
5.4.	E-504 High-Power Piezo Amplifier, Energy Recovery	24
5.4.1.	Front Panel Elements	24
5.4.2.	Operating Limits	25
5.4.3.	Specifications	26
5.4.4.	Pin Assignment.....	27
5.5.	E-505 High-Power Piezo Amplifier	28
5.5.1.	Front Panel Elements	28
5.5.2.	Operating Limits	29
5.5.3.	Specifications	30
5.5.4.	Pin Assignment.....	31
5.6.	E-506 Linearized Piezo Amplifier, Charge Control	32
5.6.1.	Front Panel Elements	32
5.6.2.	Operating Limits	33
5.6.3.	Specifications	34
5.6.4.	Pin Assignment.....	35
5.7.	E-508 High-Power Piezo Amplifier with 1100 V Output Voltage	36
5.7.1.	Front Panel Elements	36
5.7.2.	Operating Limits	37
5.7.3.	Specifications	38
5.7.4.	High-Voltage Actuator Types and Terminology.....	39
5.7.5.	Pin Assignment.....	39
5.7.6.	E-508.00 Gain Polarity and Output Range Settings	40
5.8.	E-509 Signal Conditioner / Servo-Controller Module.....	42
5.8.1.	Front Panel Elements of Modules for Dual-Electrode Capacitive Sensors	42
5.8.2.	Front Panel Elements of Modules for PISeCa Single-Electrode Capacitive Sensors	43
5.8.3.	Front Panel Elements of Modules for Strain Gauge Sensors....	44
5.8.4.	Specifications	45
5.8.5.	Pin Assignment.....	47
5.9.	E-515 Display Modules	50
5.9.1.	Front Panel Elements	50
5.9.2.	Specifications	50
5.9.3.	Pin Assignment.....	51
5.9.4.	Display Adjustment.....	52

5.10.	E-517 Computer Interface and Display Module	54
5.10.1.	Front Panel Elements	54
5.10.2.	Specifications	55
5.10.3.	Pin Assignment.....	56
5.11.	Dummy Modules.....	57
6.	Integrating Modules in Third-Party Systems.....	58
6.1.1.	Safety Measures for Integration in Third-Party Systems	58
6.1.2.	Supply Power for the Modules	59
6.1.3.	Amplifier Modules: Closing the Circuit	59
7.	Maintenance	60
7.1.	Cleaning	60
7.2.	AC Power and Line Fuses	60
8.	Customer Service	62
9.	Old Equipment Disposal	63
10.	Appendix	64
10.1.	Lifetime of PICMA® Actuators	64
10.2.	How to Measure the Amplifier Output of E-504 Modules	65
10.3.	EC Declaration of Conformity	66

1. About this Document

1.1. Goal and Target Audience of this Manual

This manual contains information on the intended use of the E-500/E-501 series piezo control electronics (referred to as “E-500/E-501 system” in this manual).

It assumes that the reader has a fundamental understanding of basic servo systems as well as motion control concepts and applicable safety procedures.

The latest versions of the user manuals are available for download (p. 6) on our website.

1.2. Symbols and Typographic Conventions

The symbols and labels in this manual have the following definitions:

DANGER



Imminently hazardous situation

If not avoided, the hazardous situation will result in death or serious injury.

- Actions to be taken to avoid the situation.

NOTICE



Dangerous situation

If not avoided, the dangerous situation will result in damage to the equipment.

- Actions to be taken to avoid the situation.

INFORMATION

Information for easier handling, tricks, tips, etc.

Symbol/ Label	Meaning
1.	Action consisting of several steps whose sequential order must be observed
2.	
➤	Action consisting of one or several steps whose sequential order is irrelevant
▪	List item
p. 5	Cross-reference to page 5
RS-232	Labeling of an operating element on the product (example: socket of the RS-232 interface)
	Warning signs affixed to the product that refer to detailed information in this manual.

1.3. Other Applicable Documents

Some of the devices which are mentioned in this documentation are described in detail in their own User Manuals or Technical Notes. The User Manuals and Technical Notes relevant for your configuration are included in delivery (see p. 14).

For the latest versions of the User Manuals and Technical Notes contact our customer service department (see p. 6).

Device	Document
E-517 computer interface and display module	PZ214E User Manual Software manuals for E-517 are on the E-517 CD (e.g. the SM148E PIMikroMove manual).
E-509 sensor / servo-control module	PZ77E User Manual
E-802 servo-control submodule	PZ150E User Manual
E-801 sensor submodule	PZ117E User Manual
E-506 charge-controlled amplifier module	E506T0002 Technical Note
Analog controller LabView driver library and Hyperbit functionality	PZ181E Software Manual E500T0011 Technical Note with download instructions
E530B0008 power supply module for E-500 chassis	E530T0003 Technical Note
E531B0005 power supply module for E-501 chassis	E531T0004 Technical Note

1.4. Downloading Manuals

INFORMATION

If a manual is missing on our website or if there are problems in downloading:

- Contact our customer service department (info@pi.ws).

The current versions of the manuals are found on our website. To download a manual, proceed as follows:

1. Open the website **http://www.pi-portal.ws**.
2. Click **Downloads**.
3. Click the corresponding category (e. g. **E Piezo Drivers & Nanopositioning Controllers**).
4. Click the corresponding product code (e. g. **E-517**).

An overview of the available file types is shown for the selected product.

5. If **(0 Files)** is shown in the **Documents** line, log in as follows to display and download the documents:
 - a) Insert the product CD in the corresponding PC drive.
 - b) Open the **Manuals** directory.
 - c) Open the Release News (e. g. **E-517_Releasenews_V_x_x_x.pdf**) on the CD of the product.
 - d) Find the user name and password in the **User login for software download** section in the Release News.
 - e) In the **User login** area on the left margin in the website, enter the user name and the password in the corresponding fields.
 - f) Click **Login**.

If **Documents (0 Files)** is still being displayed, no manuals are available:

- Contact our customer service department (info@pi.ws).

6. Click **Documents**.
7. Click the desired manual and save it on the hard disk of your PC or on a data storage medium.

2. Safety

2.1. Intended Use

The E-500/E-501 system is a laboratory device according to DIN EN 61010. It is intended to be used in interior spaces and in an environment which is free of dirt, oil and lubricants.

Corresponding to its design, the E-500/E-501 system is intended for driving capacitive loads (e. g. piezo ceramic actuators).

The E-500/E-501 system must not be used for purposes other than those named in this user manual. In particular, the E-500/E-501 system must not be used to drive ohmic or inductive loads.

The E-500/E-501 system can be used for static as well as dynamic applications.

Capacitive sensors or strain gauge sensors must be used for closed-loop operation. PI stages intended for closed-loop operation already have the corresponding sensors. Other sensors can only be used with PI approval.

2.2. General Safety Instructions

The E-500/E-501 system is built according to state-of-the-art technology and recognized safety standards. Improper use can result in personal injury and/or damage to the E-500/E-501 system.

- Only use the E-500/E-501 system for its intended purpose, and only use it if it is in a good working order.
- Read the user manual.
- Immediately eliminate any faults and malfunctions that are likely to affect safety.

The operator is responsible for the correct installation and operation of the E-500/E-501 system.

The E-500/E-501 system comes preinstalled and preconfigured. Removing modules from the chassis can result in personal injury and/or damage to the E-500/E-501 system.

- Only remove modules from the chassis when you are authorized and have the corresponding qualifications.
- Before removing modules from the chassis, remove the E-500/E-501 system from the power source by pulling the power plug.

2.3. Organizational Measures

User Manual

- Always keep this user manual next to the E-500/E-501 system when using the E-500/E-501 system.
If the user manual is lost or damaged, contact our customer service department (info@pi.ws).
- Add all information given by the manufacturer to the user manual, for example supplements or Technical Notes.
- If you pass the E-500/E-501 system on to other users, also turn over this user manual as well as other relevant information provided by the manufacturer.
- Only use the device on the basis of the complete user manual. If your user manual is incomplete and is therefore missing important information, serious or fatal injury as well as property damage can result.
- Only install and operate the E-500/E-501 system after having read and understood this user manual.

Personnel Qualification

Only authorized and qualified personnel must install, operate, maintain and clean the E-500/E-501 system.

3. Introduction



Fig. 1: Three-channel system: E-501 chassis with E-509 sensor / piezo servo-control module, E-503 piezo amplifier module and E-517 interface / display module

3.1. Model Survey

Chassis

The E-500 and E-501 chassis are based on an EMI-proven chassis with multi-function power supply and a backplane carrying all connectors to the system amplifiers, servo-controllers and interface modules. E-500/E-501 systems are assembled to order, and tested with all your modules installed.

E-500.00 19"-Chassis for Modular Piezo Controller System, 1 to 3 channels, with E530B0008 Power Supply

E-501.00 9½"-Chassis for Modular Piezo Controller System, 1 to 3 channels, with E531B0005 Power Supply

Amplifier Modules

E-503.00 Piezo Amplifier Module, -30 to 130 V, three channels

E-503.00S Piezo Amplifier Module, -30 to 130 V, one of three channels is fixed (100 V)

E-504.00F High-Power Piezo Amplifier Module, 1 channel, 280 W peak power, 100 W average power, -30 to 130 V

E-504.00S High-Power Piezo Amplifier Module, 1 channel, 280 W peak power, 100 W average power, fixed voltage 100 V

E-505.00 Piezo Amplifier Module, 2 A, -30 to 130 V, 1 channel

E-505.10 Piezo Amplifier Module for switching applications, 10 A, -30 to 130 V, 1 channel

E-505.00S Piezo Amplifier Module, 1 channel, fixed voltage 100 V

E-506.10 High Linearity Piezo Amplifier Module, 30 W average output power, -30 to 130 V, 1 channel

E-508.00 HVPZT Piezo Amplifier Module, +3 to +1100 V, 1 channel

E-508.OE HVPZT Piezo Amplifier Module, OEM version, 400 mA peak current, 1 channel

Sensor and Controller Modules

- E-509.S1** Sensor / Piezo Servo-Control Module, SGS sensor, 1 channel
- E-509.S3** Sensor / Piezo Servo-Control Module, SGS sensors, 3 channels
- E-509.S31** Sensor / Piezo Servo-Control Module, SGS sensors, 3 channels, for NanoCube® stages
- E-509.C1A** Sensor / Piezo Servo-Control Module, capacitive sensor, 1 channel
- E-509.C2A** Sensor / Piezo Servo-Control Module, capacitive sensors, 2 channels
- E-509.C3A** Sensor / Piezo Servo-Control Module, capacitive sensors, 3 channels
- E-509.E3** PISeCa Sensor / Piezo Servo-Control Module for Single-Electrode Capacitive Sensor Probes, 3 Channels
- E-509.E03** PISeCa Modular Signal Conditioner Electronics for Single Electrode Capacitive Sensors, 3 Channels

Display and Interface Modules

- E-515.01** Display Module for Piezo Voltage and Displacement, 1 channel
- E-515.03** Display Module for Piezo Voltage and Displacement, 3 channels
- E-517.i1** Interface / Display Module, 24 Bit D/A, TCP/IP, USB, RS232, IEEE 488, 1 channel
- E-517.i10** Interface / Display Module, 24 Bit D/A, TCP/IP, USB, RS232, 1 channel
- E-517.i3** Interface / Display Module, 24 Bit D/A, TCP/IP, USB, RS232, IEEE 488, 3 channels
- E-517.i30** Interface / Display Module, 24 Bit D/A, TCP/IP, USB, RS232, 3 channels

3.2. Configuration Example

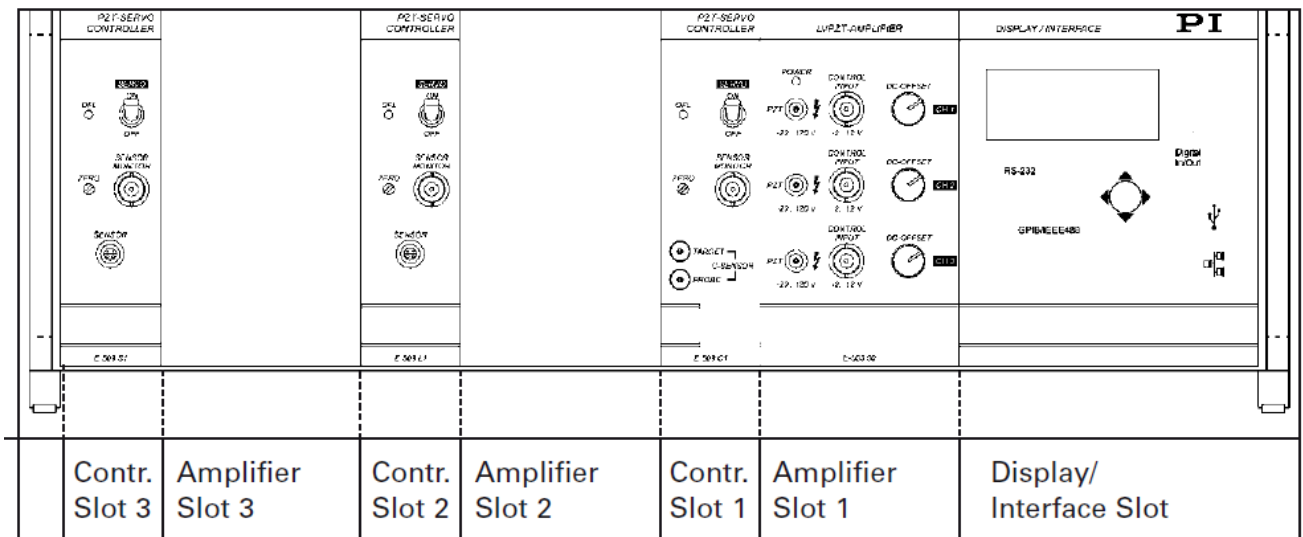

The figure above shows a three-channel configuration example consisting of the following components:

- E-500.00 chassis with power supply
- Amplifier Slot 1: E-503.00 three-channel amplifier module
- Amplifier Slots 2 and 3: not used, covered with dummy modules
- Contr. Slot 1: E-509.C1A single-channel sensor / servo-control module for capacitive sensor
- Contr. Slot 2 and 3: E-509.S1 single-channel sensor / servo-control modules for SGS sensors
- Display/Interface Slot: E-517.i3 three-channel interface / display module

3.3. Compatibility Note

NOTICE



Overheating or malfunction with improper system configuration!

In March 2011, the backplane of the chassis (E-500.00 or E-501.00) has been changed. The modules of the E-500/E-501 system have been adapted accordingly.

- „New“ chassis and modules: date of manufacture is March 2011 or later
- „Old“ chassis and modules: date of manufacture is before March 2011

If old and new components are to be combined in one system, modification of the chassis and/or modules by PI may be necessary for proper operation. Improper combination of old and new components in the E-500/E-501 system can cause damage by overheating or malfunction of the system.

With systems assembled by PI, the proper configuration is ensured. If you want to replace chassis or modules in your E-500/E-501 system:

- Contact our customer service department (p. 62).

3.4. Signal Path Diagram

The modules of the E-500/E-501 system can be combined in several configurations in an E-500 or E-501 chassis (see Section 3.2 for an example). The signal path diagram below shows a usual configuration.

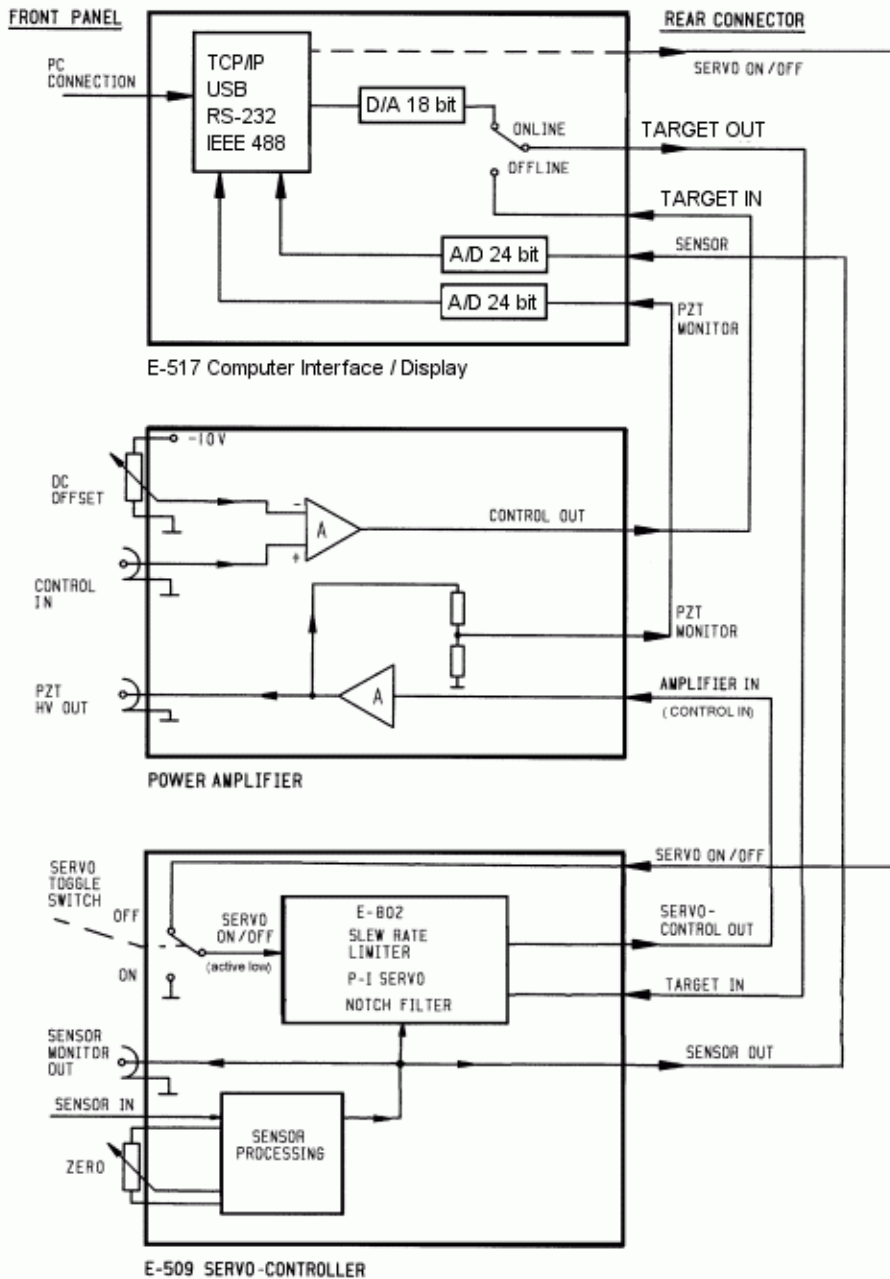





Fig. 2: Interconnections between E-517 digital piezo controller operation module, amplifier module and E-509 servo module

INFORMATION

The backplane of the chassis (E-500.00 or E-501.00) carries all connectors to the modules of the system (amplifiers, sensor / servo-control modules, interface /display modules).

3.5. Maximum Ratings

The E-500/E-501 system is designed for the following operating data:

Model	Maximum Operating Voltage 	Operating Frequency 	Maximum Current Consumption 
System in E-500.00 chassis	100 to 240 V~ (fuses: 2 x T2AH, 250 V)	50-60 Hz	210 VA
System in E-501.00 chassis	100 to 120 V~ (fuses: 2 x T2AH, 250 V)	50-60 Hz	90 VA
	220 to 240 V~ (fuses: 2 x T1AL, 250 V)	50-60 Hz	90 VA

3.6. Ambient Conditions and Classifications

The following ambient conditions and classifications must be observed for the E-500/E-501 system:

Area of application	For indoor use only
Maximum altitude	2000 m
Relative humidity	Highest relative humidity 80 % for temperatures up to 31 °C Decreasing linearly to 50% relative humidity at 40°C
Storage temperature	5 °C to 70 °C
Transport temperature	-25 °C to +85 °C
Overvoltage category	II
Protection class	I
Degree of pollution	2
Measurement category	I
Degree of protection according to IEC 60529	IP20

4. Handling

4.1. Unpacking Checklist

The E-500/E-501 system was carefully inspected, both electrically and mechanically, before shipment. Upon receiving the device, unpack it and check for any obvious signs of physical damage that may have occurred during transit.

Retain and use the original packing material in case reshipment is necessary.

The following items are shipped with every E-500/E-501 system:

- Chassis with modules installed.
- Power cord
- PZ62E User Manual (this document)
- E500T0011 Technical Note for GCS LabVIEW driver set for analog controllers

If one or more E-509 modules are installed, you should also have these items:

- PZ77E Manual for E-509
- With all models except for E-509.E03: PZ150E Manual for E-802 Servo-Controller Submodule
- With E-509.Sx and .S31 models only: PZ117E Manual for E-801 Sensor Submodule
- With E-509.S3 and .S31 models only: E-808.90 sensor monitor cable
- With E-509.CxA models only: PZ106E Manual for Capacitive Sensors
- With E-509.CxA, .E03 and .E3 models only: D-893.32 sensor monitor cable
- With E-509.E03 and .E3 models only: 3214 banana plug for ground connection of the sensor reference plane

If an E-517 module is installed, you should also have these items:

- C-815.34 RS-232 cable
- C-815.563 crossover network cable
- 000011448 USB cable
- 4347 and 4348 MDR connector for I/O socket
- E-517.CD product CD with software and manuals for E-517
- PZ214EQU User Manual for E-517, short version
- A000T0028 Technical Note for the PI Update Finder
- A000T0032 Technical Note for Using the PI Update Finder without Internet connection

4.2. Safety Measures for Installation, Start-Up and Operation

Improper installation of the E-500/E-501 system can result in personal injury and/or damage to the E-500/E-501 system.

- Install the E-500/E-501 system near the power source so that the power plug can be quickly and easily disconnected from the mains.
- Use the supplied power cord to connect the E-500/E-501 system to the power source.
- If the supplied power cord has to be replaced, use a sufficiently dimensioned component.
- Only use cables and connections that meet local safety regulations.

High temperatures can overheat the E-500/E-501 system.

- Install the E-500/E-501 system horizontally with 3 cm air circulation area.
- Do **not** install the E-500/E-501 system vertically since this prevents internal convection.
- Ensure sufficient ventilation at the installation site.

The E-500.621 chassis uses the same main connectors as the E-500.00 and E-501.00, but has incompatible pinouts.

- Do not use the modules described in this manual with the E-500.621 chassis.

Oscillations can cause irreparable damage to the piezo actuator connected to the E-500/E-501 system. Oscillations are indicated by a humming and can result from the following causes:

- The load and/or dynamics of operation differ too much from the calibration settings.
- The piezo actuator is operated near its resonance frequency.

If you notice oscillations:

- In closed-loop operation, immediately switch the servo mode off.
- In open-loop operation, immediately stop the piezo actuator.

The E-500/E-501 system performance can be reduced directly after power-on due to thermal instability.

- Switch the E-500/E-501 system on at least one hour before working with it.

The constant application of high voltage to piezos can lead to leakage currents and flashovers that destroy the ceramic.

If the E-500/E-501 system is not used, but should remain switched on to ensure the temperature stability.

- Switch the servo mode off (open-loop operation)
- Set the piezo voltage to 0 V:
 - Analog mode: The input voltage for the target value is 0 V
 - Computer-controlled mode: Corresponding commanding

4.3. Power Connection

The power connection is located on the rear panel of the chassis. Unless you request otherwise, the E-500/E-501 system will be set up for the line voltage we believe predominant in your country.

How to adapt E-500/E-501 system to a different line voltage:

- If your system uses a 19" chassis (E-500.00), it is equipped with a wide-range power supply and with fuses that are admissible for both 115 V and 230 V operation. No settings need be changed when connecting the device to a different line voltage.
- If your system uses a 9.5" chassis (E-501.00), it requires new fuses when it is to be connect to a different line voltage. Replace both fuses as described in "AC Power and Line Fuses" on p. 60.

4.4. First Electrical Checks

Check the device electrically when using it for the first time after unpacking. Perform these steps:

1. Connect the power cord.
2. Switch the device on without any piezo actuators connected. The power switch is at the rear next to the power cord socket.
3. Now the green LED on the amplifier module lights up.
4. *If an E-517 Interface / Display module is installed:*
The display shows the main screen, see E-517 user manual for details.
5. Set the SERVO switch on the E-509 module to OFF.
6. *If an E-517 Interface / Display module is installed:*
Turn the DC-OFFSET potentiometer and watch the voltage display. The voltage reading is the current output voltage at the PZT output sockets.
The position values in the display have no meaning, because the piezo actuators and sensors are not yet connected.

If these steps could be performed without unexpected results, the device has passed the electrical checks.

4.5. Connecting Cables

INFORMATION

Each E-509 sensor / servo-control module is calibrated with one particular piezo actuator. That piezo actuator must always be connected to that same controller channel. Labels on the rear panel of the device indicate the serial numbers of the piezo actuators that belong with each channel.

After the system has passed the electrical checks, the piezo actuators can be connected and the system can be operated. Follow these steps:

1. Switch the device OFF.
2. Connect the piezo actuators.

Each piezo actuator is equipped with cables for the piezo operating voltage and for the sensor, if present. Connect the first cable to the PZT output socket on the amplifier module and second with the sensor input socket on the piezo servo-controller.

If capacitive sensors are used, two sensor cables must be connected to the servo-controller. The cable labeled 'T' must be connected to the T socket (target signal) and the cable labeled 'P' to the P socket (probe signal).

4.6. Starting Operation

4.6.1. Analog Operation

INFORMATION

The external analog signal can be generated by a computer (e.g. from a data acquisition board). You can use the PI LabVIEW analog driver to generate the analog signal.

➤ See the E500T0011 Technical Note for how to download the driver set from our website.

1. Turn all DC-OFFSET potentiometers CCW (zero offset).
2. Turn all SERVO switches to OFF (open-loop operation).

Position servo-controllers can be operated in closed-loop (SERVO=ON, control input is interpreted as target position) and open-loop (SERVO=OFF, control input determines the output voltage directly) modes.

In closed-loop mode, the servo-control circuit is active and compares the sensor signal with the target position. Hysteresis effects, nonlinearities and drift effects are eliminated.

In open-loop mode, the servo-control circuit is deactivated. The device works as a high-voltage amplifier. The input signal is amplified by the gain factor, and output to the piezo actuator. The output signal can also be offset manually with the DC-OFFSET potentiometer. In open-loop, the position sensor, if installed, is still active and the real-time position reading is correct.

3. Turn the power on.

The standard screen appears on the display. The current output voltages and displacements derived from the sensor signals are displayed for all channels. Because the controller is set to open-loop mode, the sensor reading is not fed back to control the position. If external forces act on the piezo actuator, its length will change accordingly and so will the sensor reading.

4. Switch the Servo switches to ON (closed-loop).

Now the displacement is controlled in closed-loop servo-mode. The display shows the current displacement values, as before.

5. Use the DC-Offset potentiometer to change the expansion.
6. Apply an external analog signal from 0 to +10 volts to control the expansion over the nominal range.

The expansion of the piezo actuator can be controlled either by the DC-OFFSET potentiometer or by an analog control input voltage applied to the CONTROL INPUT socket. In the latter case, the potentiometer setting is used as an offset to the control input voltage. This allows generation of unipolar output voltages from bipolar control voltages.

7. Watch the yellow overflow LED on the servo-module. If it lights up, the amplifier output is being clipped at one of its limits and the current displacement of the piezo actuator no longer complies with the control signal. Use the ZERO trim potentiometer to adjust the sensor reading window. Trim the potentiometer until the overflow LED stays dark.

4.6.2. Computer Controlled Operation

If an E-517 Interface/display unit is installed, remote control via TCP/IP, USB, RS-232 or IEEE-488 interface is possible. A comprehensive command set allows controlling any motion of the piezo actuator with maximum resolution (depending on the sensor installed).

See User Manual for the interface unit for details.

5. Module Description

5.1. E-500.00 19" Chassis with Power Supply

5.1.1. Specifications

Model	E-500.00
Function	19"-Chassis for Piezo Controller System: Amplifier Modules, Sensor- / Servo-Control Modules, Interface / Display Modules
Channels	1, 2, 3 (up to 3 amplifier modules)
Dimensions	450 x 132 x 296 mm + handles +feet
Operating Voltage	100 - 240 V~, 50 - 60 Hz
Max. power consumption	210 VA
Internal power supply	E530B0008

5.1.2. Dimensions

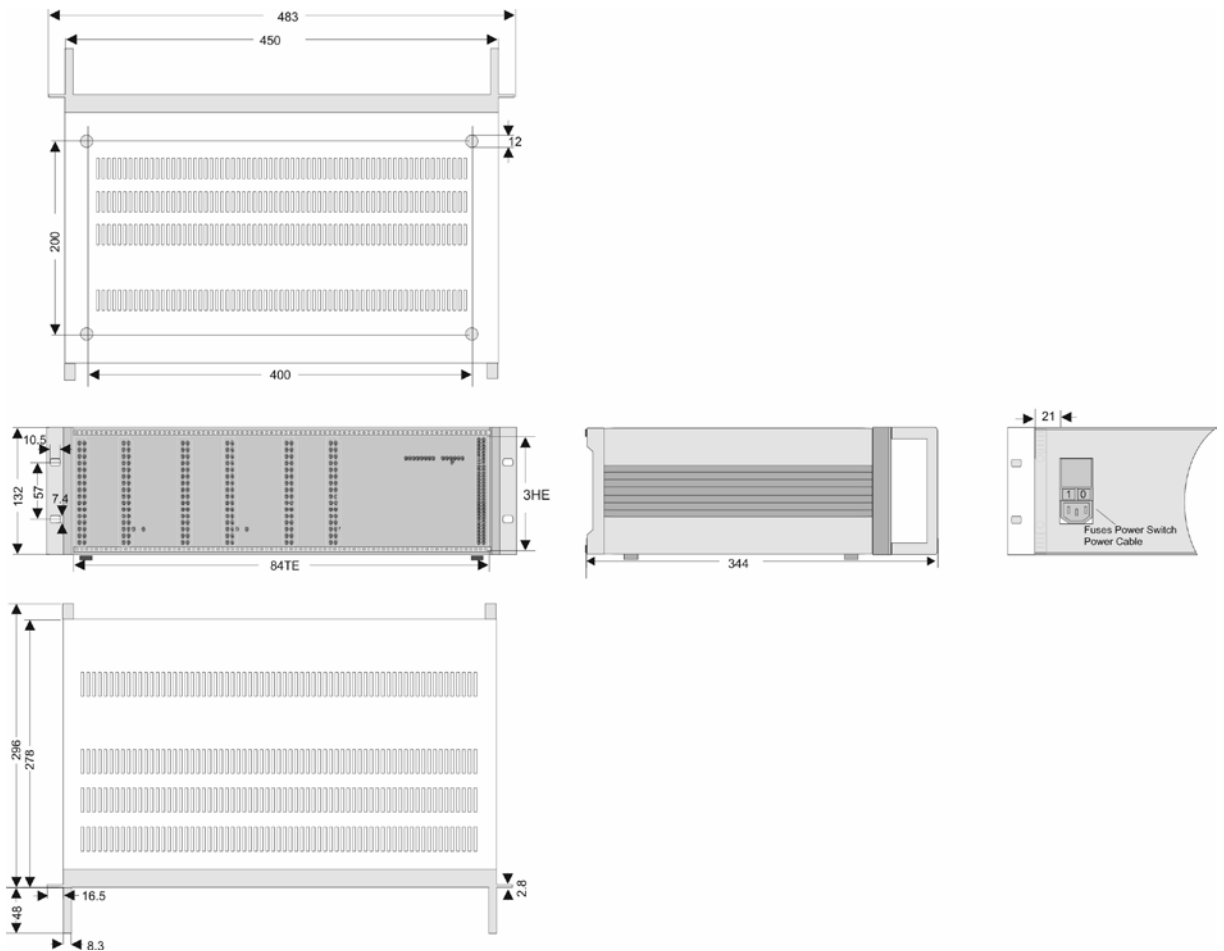

Fig. 3: E-500.00 chassis

5.2. E-501.00 9.5" Chassis with Power Supply

5.2.1. Specifications

Model	E-501.00
Function	9.5"-Chassis for Piezo Controller System: Amplifier Modules, Sensor- / Servo-Control Modules, Interface / Display Modules
Channels	1, 3 (1 amplifier module)
Dimensions	236 x 132 x 296 mm + handles + feet
Operating Voltage	100 - 120 / 220 - 240 V~, 50 - 60 Hz
Max. power consumption	90 VA
Internal power supply	E531B0005

5.2.2. Dimensions

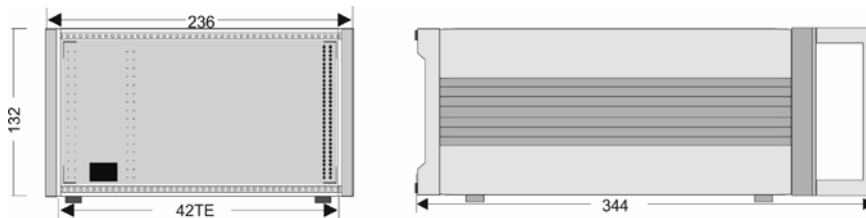

Fig. 4: E-501.00 chassis

5.3. E-503 3-Channel Piezo Amplifier

DANGER



High Voltage!

The E-503 amplifier can output up to 130 V. Touching this High Voltage can result in serious or even lethal injury due to electric shock.

- Only authorized and qualified personnel must install, operate, maintain and clean the E-503 amplifier.
- Operate a piezo actuator on a “PZT” socket only when it is connected to a protective earth conductor.

5.3.1. Front Panel Elements



Fig. 5: E-503.00 amplifier module



Fig. 6: E-503.00S amplifier module

Labeling	Type	Function
POWER	LED Green/off	Amplifier state: <ul style="list-style-type: none"> ▪ Green: E-503 is ready for normal operation. ▪ Off: The E-500/E-501 system is switched off.
PZT -30 to 130 V	LEMO ERA.00.250.CTL	Output of the piezo voltage for the piezo actuator in the stage. Voltage in the range of -30 to 130 V.
E-503.00S only: PZT 100 V	LEMO ERA.00.250.CTL	Output of the piezo voltage for the piezo actuator in the stage. Fixed voltage of 100 V for piezo tip/tilt stages.

Labeling	Type	Function
CONTROL INPUT -2 to +12 V	BNC	In analog operation, this control input voltage gives the target (either as voltage or position, depending on the servo mode). The input signal should always be in the range of 0 to 10 V (excursions to -2 or +12 V may cause overflow, especially with servo on, and reduce actuator lifetime). The control input range can be shifted using the "DC-OFFSET" potentiometer. The control input voltage can also be a computer-generated analog signal (e.g. from a DAQ board). You can use a PI LabVIEW Analog Driver set to generate that analog signal. See "Analog Operation" on p. 17 for details.
DC-OFFSET	10-turn potentiometer	Adds 0 to 10 V to the "CONTROL INPUT" signal (only relevant in analog operation, see p. 17 for details)

5.3.2. Operating Limits

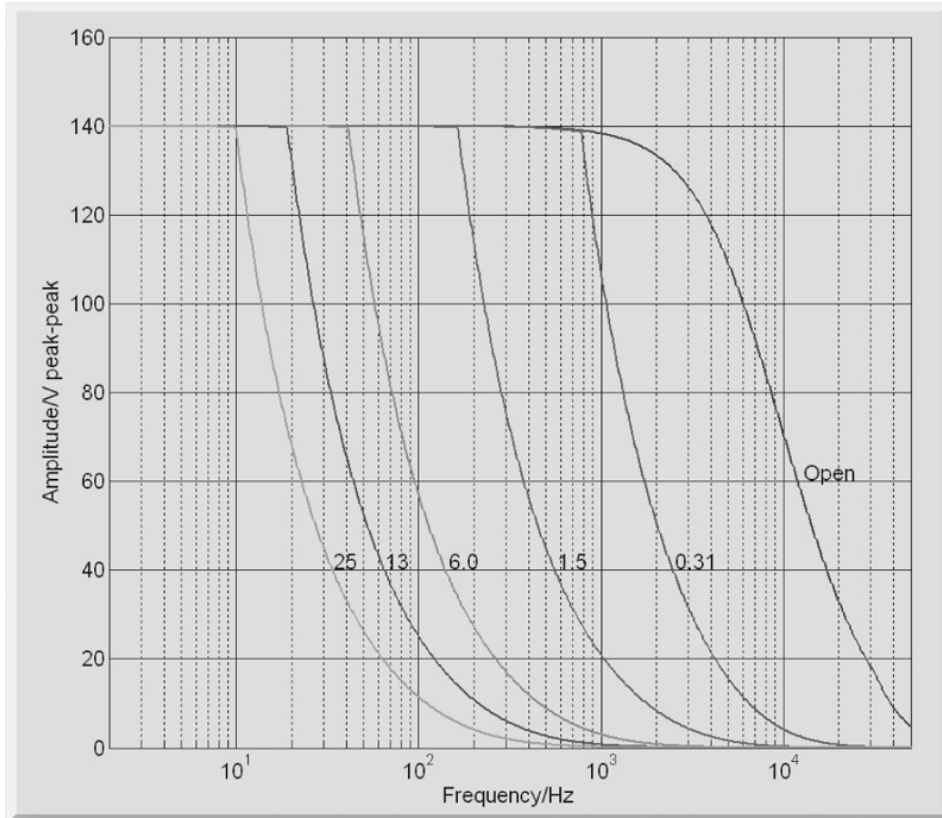

Fig. 7: E-503 operating limits with various piezo loads (open-loop), capacitance is measured in μF

5.3.3. Specifications

	E-503.00	E-503.00S
Function	Power amplifier	Power amplifier for tip/tilt systems
Channels	3	3
Amplifier		
Control input voltage	-2 to 12 V	-2 to 12 V Channel 3: no control input
Output voltage	-30 to 130 V	-30 to 130 V Channel 3: 100 V fixed voltage
Peak current per channel, <10 ms	>140 mA (typical 180 mA)	>140 mA (typical 180 mA)
Average current per channel, >10 ms	>70 mA	>70 mA
Current limitation	Short-circuit-proof	Short-circuit-proof
Voltage gain	10 ±0.1	10 ±0.1 (not with channel 3)
Input impedance	100 kΩ / 1 nF	100 kΩ / 1 nF (not with channel 3)
Interface and operation		
Piezo connector	3 × LEMO ERA.00.250.CTL	3 × LEMO ERA.00.250.CTL
Analog input / control in	3 × BNC	2 × BNC
DC Offset	3 × 10-turn pot., adds 0 to 10 V to Control In	2 × 10-turn pot., adds 0 to 10 V to Control In
Miscellaneous		
Operating temperature range	5 to 50 °C	5 to 50 °C
Overtemp protection	Deactivation at 85 °C	Deactivation at 85 °C
Dimensions	14HP/3U	14HP/3U
Mass	0.9 kg	0.9 kg
Operating voltage	E-500/E-501 system	E-500/E-501 system
Max. power consumption	< 40 W, limited by temperature	< 40 W, limited by temperature

5.3.4. Pin Assignment

32-pin connector, DIN 41612, male

Row	PIN a	PIN c
2	Power Fail	OUT: ch1 (BNC+Offset)
4	IN: ch1	OUT: ch1 (monitor of piezo voltage (PZT \div 100))
6	nc	nc
8	nc	nc
10	nc	OUT: ch2 (BNC+Offset)
12	IN: ch2	OUT: ch2 (monitor of piezo voltage (PZT \div 100))
14	internal use Bus_A	internal use Bus_B
16	internal use Bus_Vcc	internal use Bus_GND
18	nc	OUT: ch3 (BNC+Offset)*
20	IN: ch3*	OUT: ch3 (monitor of piezo voltage (PZT \div 100))
22	GND (measurement)	GND (measurement)
24	GND	GND
26	IN: +24 V to +27 V	IN: +24 V to +27 V
28	IN:-37 V	OUT: -10 V
30	IN:+137 V	IN: +137 V
32	Protective earth (chassis)	Protective earth (chassis)

* E-503.00S: nc

5.4. E-504 High-Power Piezo Amplifier, Energy Recovery

DANGER



High Voltage!

The E-504 amplifier can output up to 130 V. Touching this High Voltage can result in serious or even lethal injury due to electric shock.

- Only authorized and qualified personnel must install, operate, maintain and clean the E-504 amplifier.
- Operate the piezo actuator on the “PZT” socket only when it is connected to a protective earth conductor.

5.4.1. Front Panel Elements





Fig. 8: E-504.00F amplifier module



Fig. 9: E-504.00S amplifier module

Labeling	Type	Function
POWER	LED Green/off	Amplifier state: <ul style="list-style-type: none"> ▪ Green: E-504 is ready for normal operation. ▪ Off: The E-500/E-501 system is switched off.
E-504.00F only: DC-OFFSET	10-turn potentiometer	Adds 0 to 10 V to the “CONTROL INPUT” signal (only relevant in analog operation, see p. 17 for details)
E-504.00F only: CONTROL INPUT -2 to +12 V	SMB	In analog operation, this control input voltage gives the target (either as voltage or position, depending on the servo mode). The input signal should always be in the range of 0 to 10 V (excursions to -2 or +12 V may cause overflow, especially with servo on, and reduce actuator lifetime). The control input range can be shifted using the “DC-OFFSET” potentiometer. The control input voltage can also be a computer-generated analog signal (e.g. from a DAQ board). You can use a PI LabVIEW Analog Driver set to generate that analog signal. See “Analog Operation” on p. 17 for details.

Labeling	Type	Function
E-504.00F only: PZT  -30 to 130 V	LEMO ERA.00.250.CTL	Output of the piezo voltage for the piezo actuator in the stage. Voltage in the range of -30 to 130 V.
E-504.00S only: PZT  100 V	LEMO ERA.00.250.CTL	Output of the piezo voltage for the piezo actuator in the stage. Fixed voltage of 100 V for piezo tip/tilt stages.

5.4.2. Operating Limits

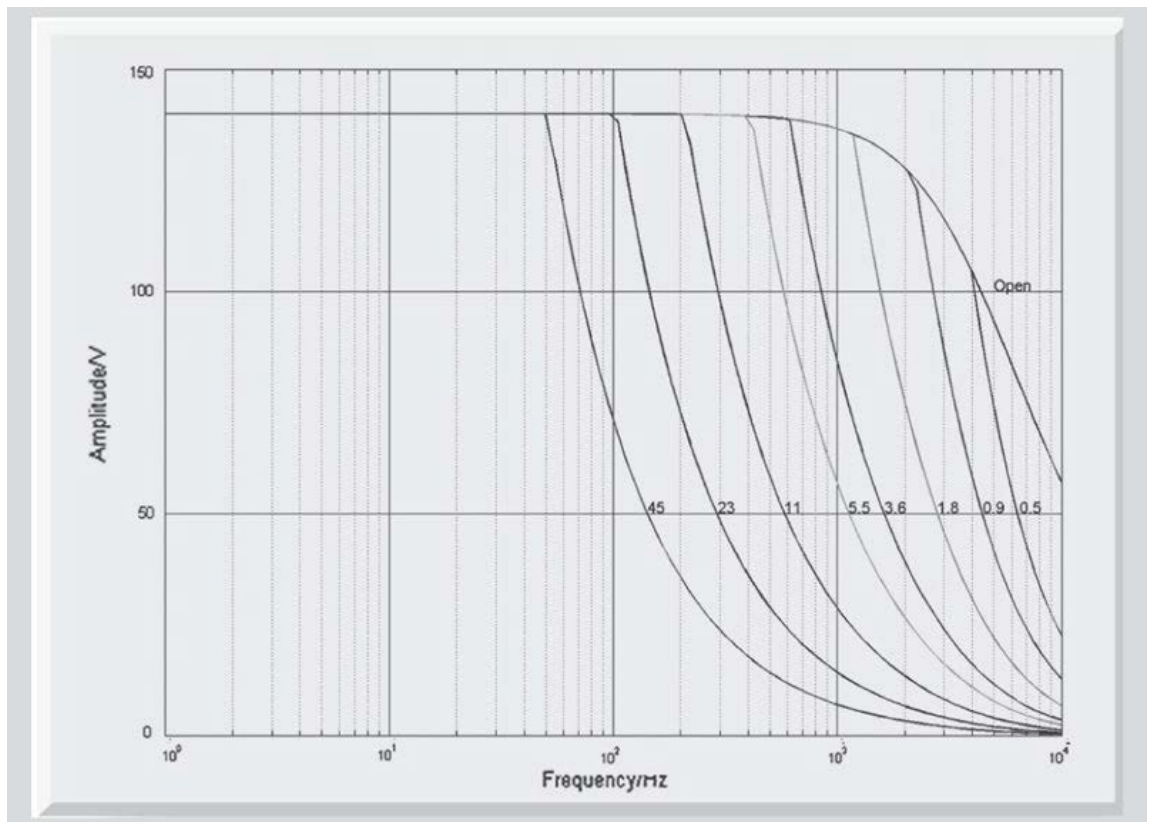

Fig. 10: E-504 operating limits with various piezo loads (open-loop), capacitance is measured in μF

5.4.3. Specifications

	E-504.00F	E-504.00S
Function	Power amplifier with energy recovery, 1 channel	Power amplifier with energy recovery, 1 channel, for tip/tilt systems
Amplifier		
Control input voltage range	-2 to +12 V	-
Output voltage	-30 V to +130 V	100 V
Peak output power < 5ms	280 W	280 W
Average output power	Equivalent to 100 W reactive power	Equivalent to 100 W reactive power
Peak output current < 5 ms	2000 mA	2000 mA
Average output current	1000 mA	1000 mA
Current limitation	Short-circuit-proof	Short-circuit-proof
Voltage gain	10 ±0.1	-
Ripple, noise	5 mVrms / < 10 kHz, 20 mVpp / < 10 kHz < 30mVrms / < 100 kHz, < 100mVpp / 100 kHz < 150mVpp / 20 MHz	< 30 mVrms / < 100 kHz, < 100 mVpp / 100 kHz < 150 mVpp / 20 MHz
Base load (internal)*	1.5 µF	1.5 µF
Output impedance	1.5 µH / 0.5 Ω / 1.5 µF	1.5 µH / 0.5 Ω / 1.5 µF
Amplifier step resolution	10 mV	-
Amplifier type	Class D, switching amp (100 kHz)	Class D, switching amp (100 kHz)
Input impedance	100 kΩ	-
Interfaces and operation		
Piezo connector	LEMO ERA.00.250.CTL	LEMO ERA.00.250.CTL
Analog input	SMB	-
DC-Offset	10-turn pot., adds 0 to +10 V to Control In	-
Miscellaneous		
Operating temperature range	+5 to +50 °C	+5 to +50 °C
Dimensions	One 14T slot wide, 3H high	One 14T slot wide, 3H high
Mass	0.9 kg	0.9 kg
Operating voltage	E-500/E-501 system	E-500/E-501 system
Max. power consumption	< 30 W	< 30 W

* The internal base load is required to obtain a stable amplifier output voltage when no external piezo load is connected. The total load is the sum of internal base load and external piezo load. Note that the amplifier output power is allocated to the internal and external loads according to their capacitance values. This is of particular importance under large-signal conditions.





Examples: The small-signal capacitance of the connected piezo actuator is 550 nF, hence its large-signal capacitance is approx. 1.1 µF (2 * 550 nF). Under large-signal conditions,

approx. 58 W will be allocated to the internal base load (1.5 μ F), while approx. 42 W will be available for the external piezo load.

With a small-signal capacitance of 1 μ F, the piezo actuator would have a large-signal capacitance of 2 μ F, and approx. 57 W would be available for it.

5.4.4. Pin Assignment

32 pin connector, DIN 41612, male

Row	PIN a	PIN c
2	Power Fail	OUT: ch1 (SMB+Offset)*
4	IN: ch1*	OUT: ch1 (monitor)
6	Piezo voltage GND 	Piezo voltage GND 
8	OUT: piezo voltage 	OUT: piezo voltage 
10	n.c.	n.c.
12	n.c.	n.c.
14	IN: sync 200 kHz TTL	internal use, Bus_B
16	internal use, Bus_Vcc	internal use, Bus_GND
18	n.c.	n.c.
20	n.c.	n.c.
22	GND (measurement)	GND (measurement)
24	GND (power)	GND (power)
26	IN: +24 to +27 V	IN: +24 to +27 V
28	n.c.	n.c.
30	n.c.	n.c.
32	Protective earth (chassis)	Protective earth (chassis)

* E-504.00S: Pins 2c and 4a are shorted.

5.5. E-505 High-Power Piezo Amplifier

DANGER



High Voltage!

The E-505 amplifier can output up to 130 V. Touching this High Voltage can result in serious or even lethal injury due to electric shock.

- Only authorized and qualified personnel must install, operate, maintain and clean the E-505 amplifier.
- Operate the piezo actuator on the “PZT” socket only when it is connected to a protective earth conductor.

5.5.1. Front Panel Elements





Fig. 11: E-505.00 and E-505.10 amplifier modules



Fig. 12: E-505.00S amplifier module

Labeling	Type	Function
POWER	LED Green/off	Amplifier state: <ul style="list-style-type: none"> ▪ Green: E-505 is ready for normal operation. ▪ Off: The E-500/E-501 system is switched off.
E-505.00 and .10 only: DC-OFFSET	10-turn potentiometer	Adds 0 to 10 V to the “CONTROL INPUT” signal (only relevant in analog operation, see p. 17 for details)
E-505.00 and .10 only: CONTROL INPUT -2 to +12 V	BNC	In analog operation, this control input voltage gives the target (either as voltage or position, depending on the servo mode). The input signal should always be in the range of 0 to 10 V (excursions to -2 or +12 V may cause overflow, especially with servo on, and reduce actuator lifetime). The control input range can be shifted using the “DC-OFFSET” potentiometer. The control input voltage can also be a computer-generated analog signal (e.g. from a DAQ board). You can use a PI LabVIEW Analog Driver set to generate that analog signal. See “Analog Operation” on p. 17 for details.

Labeling	Type	Function
E-505.00 and .10 only: PZT  -30 to 130 V	LEMO ERA.00.250.CTL	Output of the piezo voltage for the piezo actuator in the stage. Voltage in the range of -30 to 130 V.
E-505.00S only: PZT  100 V	LEMO ERA.00.250.CTL	Output of the piezo voltage for the piezo actuator in the stage. Fixed voltage of 100 V for piezo tip/tilt stages.

5.5.2. Operating Limits

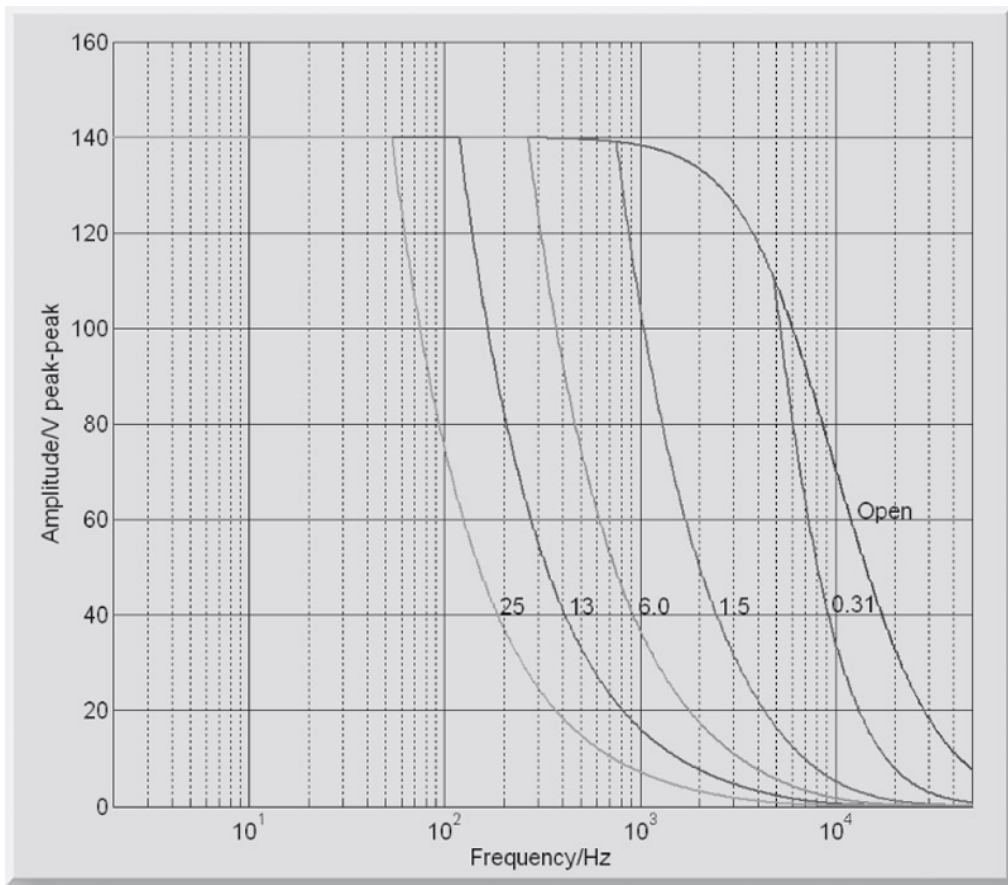



Fig. 13: E-505 operating limits with various piezo loads (open-loop), capacitance is measured in μF

5.5.3. Specifications

	E-505.00	E-505.10	E-505.00S
Function	Power amplifier	Power amplifier	Power amplifier for tip/tilt systems
Channels	1	1	1
Amplifier			
Control input voltage	-2 to +12 V	-2 to +12 V	-
Output voltage	-30 to +130 V	-30 to +130 V	100 V
Peak current	2 A (<3 ms)	10 A (<200 μ s)	2 A (<3 ms)
Average current	250 mA	250 mA	250 mA
Current limitation	Short-circuit-proof	Short-circuit-proof	Short-circuit-proof
Noise, 0 to 100 kHz	<0.6 mVrms	<1.0 mVrms	<0.6 mVrms
Voltage gain	10 \pm 0.1	10 \pm 0.1	-
Input impedance	1 M Ω / 1 nF	1 M Ω / 1 nF	-
Interface and operation			
Piezo connector	LEMO ERA.00.250.CTL	LEMO ERA.00.250.CTL	LEMO ERA.00.250.CTL
Analog input	BNC	BNC	-
DC Offset	10-turn pot., adds 0 to 10 V to Control In	10-turn pot., adds 0 to 10 V to Control In	-
Miscellaneous			
Operating temperature range	+5 to +50 $^{\circ}$ C	+5 to +50 $^{\circ}$ C	+5 to +50 $^{\circ}$ C
Overtemp protection	Deactivation at +85 $^{\circ}$ C	Deactivation at +85 $^{\circ}$ C	Deactivation at +85 $^{\circ}$ C
Dimensions	14HP/3U	14HP/3U	14HP/3U
Ground	0.9 kg	0.9 kg	0.9 kg
Operating voltage	E-500/E-501 system	E-500/E-501 system	E-500/E-501 system
Max. power consumptions	55 W	55 W	55 W

5.5.4. Pin Assignment

32 pin connector, DIN 41612, male

Row	PIN a		PIN c
2	Power Fail		OUT: ch1 (BNC+Offset)*
4	IN: ch1*		OUT: ch1 (monitor)
6	Piezo voltage GND		Piezo voltage GND 
8	OUT: piezo voltage		OUT: piezo voltage
10	n.c.		n.c.
12	n.c.		n.c.
14	internal use, Bus_A		internal use, Bus_B
16	internal use, Bus_Vcc		internal use, Bus_GND
18	n.c.		n.c.
20	n.c.		n.c.
22	GND (measurement)		GND (measurement)
24	GND (power)		GND (power)
26	IN: +24 V to +27V		IN: +24 V to +27 V
28	IN: -37 V		OUT: -10 V
30	IN: +137 V		IN: +137 V
32	Protective earth (chassis)		Protective earth (chassis)

* E-505.00S: Pins 2c and 4a are shorted.

5.6. E-506 Linearized Piezo Amplifier, Charge Control

DANGER



High Voltage!

The E-506 amplifier can output up to 130 V. Touching this High Voltage can result in serious or even lethal injury due to electric shock.

- Only authorized and qualified personnel must install, operate, maintain and clean the E-506 amplifier.
- Operate the piezo actuator on the “PZT” socket only when it is connected to a protective earth conductor.

INFORMATION

Standard nanopositioning stages are not suitable for operation with the E-506.10 and cannot be connected via an adapter!

See the E506T0002 Technical Note for a more detailed description of the E-506.10 charge-controlled amplifier module. **Front Panel Elements**



Fig. 14: E-506.10 amplifier module

Labeling	Type	Function
POWER	LED Green/off	Amplifier state: <ul style="list-style-type: none"> ▪ Green: E-506 is ready for normal operation. ▪ Off: The E-500/E-501 system is switched off.
OVERTEMP	LED Red/off	Overtemp state: <ul style="list-style-type: none"> ▪ Red: Piezo voltage output is deactivated due to overtemp condition at the piezo actuator (see below) ▪ Off: No overtemp condition
DC-OFFSET	10-turn potentiometer	Adds 0 to 10 V to the “CONTROL INPUT” signal (only relevant in analog operation, see p. 17 for details)

Labeling	Type	Function
CONTROL INPUT -2 to +12 V	BNC	In analog operation, this control input voltage gives the target (either as voltage or position, depending on the servo mode). The input signal should always be in the range of 0 to 10 V (excursions to -2 or +12 V may cause overflow, especially with servo on, and reduce actuator lifetime). The control input range can be shifted using the “DC-OFFSET” potentiometer. The control input voltage can also be a computer-generated analog signal (e.g. from a DAQ board). You can use a PI LabVIEW Analog Driver set to generate that analog signal. See “Analog Operation” on p. 17 for details.
TEMP SENSOR	LEMO EPL.0S.303.HLN	Connection for PT1000 temperature sensor or dummy plug. Pinout on p. 35
PZT  -30 to +130 V	LEMO EGG.0B.302.CLL Pinout on p. 35	Output of the piezo voltage for the piezo actuator in the stage. Piezo voltage output is deactivated if a temperature of 150 °C is exceeded at the piezo actuator. Automatic reactivation at a temperature < 146 °C

5.6.2. Operating Limits

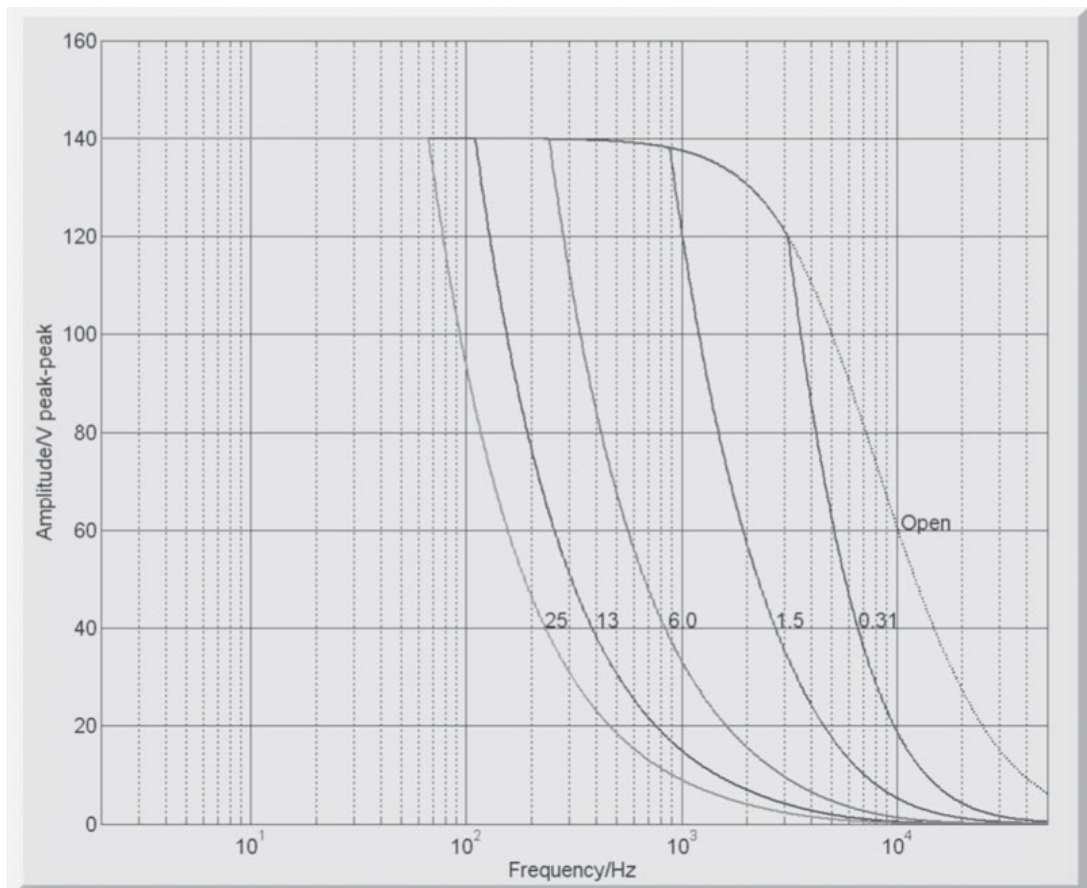

Fig. 15: E-506 operating limits with various piezo loads (open-loop), capacitance is measured in μF . The minimum capacitive load is $0.3 \mu\text{F}$

5.6.3. Specifications

	E-506.10	Tolerance
Function	Linearized amplifier module, charge-controlled	
Channels	1	
Amplifier		
Input voltage	-2 to +12 V	
Output voltage*	-30 to 130 V	
Peak output power, < 2.5 ms	280 W	max.
Average output power	30 W	max.
Peak current, < 2.5 ms	2 A	
Average current	250 mA	
Current limitation	Short-circuit-proof	
Ripple, noise 0 to 100 kHz	<0.6 mVrms	
Reference capacitance (adjustable)	1 to 280 μ F	
Input impedance	1 M Ω / 1 nF	
Interfaces and operation		
Piezo connector (voltage output)	LEMO 2-pin EGG.0B.302.CLL	
Analog input	BNC	
Display	LEDs for power and piezo overtemp	
DC Offset	10-turn pot., adds 0 to 10 V to Control In	
Piezo temperature sensor (input)	PT 1000; LEMO socket; deactivation of the piezo voltage output at 150 °C	
Miscellaneous		
Operating temperature range	+5 to +50 °C	
Dimensions	14HP/3U	
Mass	0.9 kg	
Operating voltage	E-500/E-501 system	
Power consumption	55 W	max.

*Max. 85°C, deactivation of the piezo voltage output (internal overtemp protection)

Minimum frequencies* for charge-controlled operation:

Capacitance (piezo actuator)	f_{trans}
0.33 μ F	250 mHz
1.06 μ F	80 mHz
6.2 μ F	9 mHz
14 μ F	4 mHz

* Voltage-controlled operation for lower frequencies

5.6.4. Pin Assignment

PZT High Voltage



Top pin: Plus

Bottom pin: Return conductor (minus; the actuator connected must have a floating-ground construction!)

Housing: Protective earth

PT1000 Temperature sensor

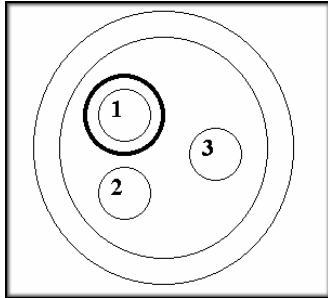

LEMO EPL.OS.303.HLN
Temperature sensor socket

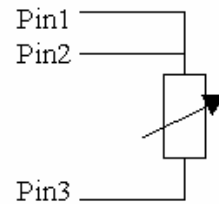

Schematic circuit diagram of temperature sensor

- Pin 1: Temp_SA
- Pin 2: Temp_S
- Pin 3: GND/PE
- Housing: Protective earth conductor/GND/PE

32 pin connector, DIN 41612, male

Row	PIN a	PIN c
2	Power Fail	OUT: ch1 (BNC+Offset)
4	IN: ch1	OUT: ch1 (monitor)
6	Piezo voltage GND	Piezo voltage GND
8	OUT: piezo voltage	OUT: piezo voltage
10	n.c.	n.c.
12	n.c.	n.c.
14	n.c.	n.c.
16	IN: -15 V	n.c.
18	n.c.	n.c.
20	n.c.	n.c.
22	GND (measurement)	GND (measurement)
24	GND (power)	GND (power)
26	IN:+24 V to +27 V	IN: +24 V to +27 V
28	IN: -37 V	OUT: -10 V
30	IN: +137 V	IN: +137 V
32	Protective earth (chassis)	Protective earth (chassis)

5.7. E-508 High-Power Piezo Amplifier with 1100 V Output Voltage

DANGER



High Voltage!

The E-508 amplifier can output up to 1100 V. Touching this High Voltage can result in serious or even lethal injury due to electric shock.

- Only authorized and qualified personnel must install, operate, maintain and clean the E-508 amplifier.
- Operate the piezo actuator on the “PZT HIGH VOLTAGE” socket only when it is connected to a protective earth conductor.

5.7.1. Front Panel Elements



Fig. 16: E-508.00 amplifier module



Fig. 17: E-508.OE amplifier module

Labeling	Type	Function
POWER	LED Green/off	Amplifier state: <ul style="list-style-type: none"> ▪ Green: E-508 is ready for normal operation. ▪ Off: The E-500/E-501 system is switched off.
E-508.00 only: DC-OFFSET	10-turn potentiometer	Adds 0 to 10 V to the “CONTROL INPUT” signal (only relevant in analog operation, see p. 17 for details)

Labeling	Type	Function
CONTROL INPUT	E-508.00: BNC E-508.OE: SMB	In analog operation, this control input voltage gives the target (either as voltage or position, depending on the servo mode). Input voltage range: <ul style="list-style-type: none"> ▪ Servo off: $\pm 1/100$ of selected output range ▪ Servo on: 0 to 10 V With E-508.00, the control input range can be shifted using the "DC-OFFSET" potentiometer. The control input voltage can also be a computer-generated analog signal (e.g. from a DAQ board). You can use a PI LabVIEW Analog Driver set to generate that analog signal. See "Analog Operation" on p. 17 for details. See the „Specifications“ table below for the input voltage range.
PZT  High Voltage	LEMO EGG.0B.701.CJL.1173 Pinout on p. 39	Output of the piezo voltage for the piezo actuator in the stage. See the „Specifications“ table below for the output voltage range.

5.7.2. Operating Limits

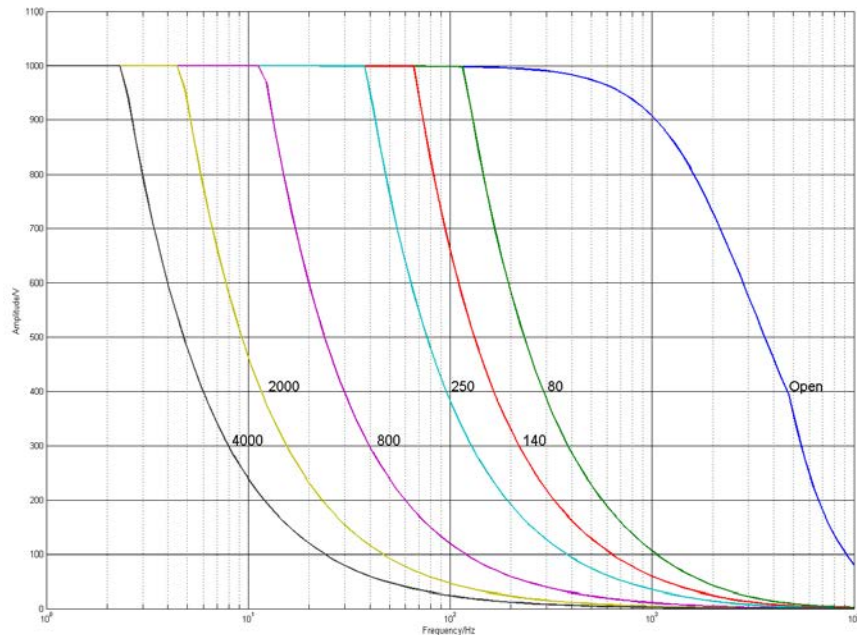

Fig. 18: E-508 operating limits with various piezo loads (open-loop), capacitance is measured in nF

5.7.3. Specifications

	E-508.00	E-508.OE	Unit
Function	Power amplifier for PICA high-voltage piezos	Power amplifier for PICA high-voltage piezos	
Amplifier			
Output voltage	3 to + 1100 (Standard) (-260 to + 780 - 550 to + 550 +260 to -780 - 3 to - 1100) (jumper-selectable)	3 to + 1100 (Standard) (-260 to + 780 - 550 to + 550 +260 to -780 - 3 to - 1100) (factory-settable)	V
Amplifier channels	1	1	
Average output power	13	18	W
Peak output power, < 5 ms	50	400	W
Average current	12	18	mA
Peak current, < 5ms	50	400	mA
Amplifier bandwidth, small signal	6	10	kHz
Amplifier bandwidth, large signal	50 (200 nF)	70 (200 nF)	Hz
Ripple, noise 0 to 100 kHz	5 50 (100 nF)	20 200 (100 nF)	mV _{RMS} mV _{P-P}
Current limitation	Short-circuit-proof	Short-circuit-proof	
Voltage gain	+100 ±1, -100 ±1 (selectable)	+100 ±1, -100 ±1 (selectable)	
Control input voltage	Servo off: ±1/100 of selected output range Servo on: 0 to 10 V	Servo off: ±1/100 of selected output range Servo on: 0 to 10 V	
Input impedance	100	100	kΩ
Interfaces and operation			
Piezo voltage output	LEMO EGG.0B.701.CJL.1173	LEMO EGG.0B.701.CJL.1173	
Input	BNC	SMB	
DC-Offset	10-turn pot., adds 0 to 10 V to Control In	-	
Miscellaneous			
Operating voltage	E-500/E-501 system	E-500/E-501 system	
Operating temperature range	+5 °C to +50 °C output power 10 % derated over 40 °C)	+5 °C to +50 °C (output power 10 % derated over 40 °C)	°C
Mass	0.75	0.75	kg
Dimensions	14 HP/3 U	14 HP/3 U	

5.7.4. High-Voltage Actuator Types and Terminology

If you order the actuator and controller together, and/or provide PI with sufficient information about your application, then the actuator connector, output voltage range and gain polarity will be set up as required.

If you are connecting other actuators or wiring your own connector, read the discussion of actuator type carefully and any documentation that came with the actuator.

Bipolar Actuators

Here the output voltage swing is so chosen that the actuator sees both negative and positive high voltages. The output always has one lead at 0 V, and here the other is in a zero-crossing range, commonly ± 500 V.

Unipolar Actuators

The notation of “positive” and “negative” polarity of piezo actuators does not refer to their direction of motion. Unipolar piezos of any polarity will elongate when a higher voltage is applied to their (+) than to their (-) terminal.

“Positive” and “negative” refers to the sign of the voltage on the core of the cable.

All standard PI piezo actuators with 2-conductor LEMO connectors have positive polarity.

5.7.5. Pin Assignment

PZT High Voltage

Type: LEMO EGG.0B.701.CJL.1173

HV OUT: High-voltage output
 PGND: Power ground
 Housing: Cable shield

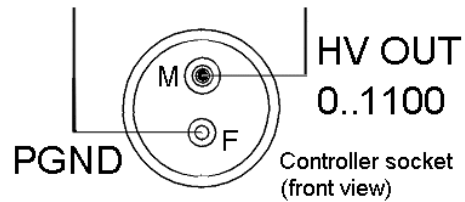

32-pin connector, DIN 41612, male

Row	PIN a	PIN c
2	IN: Power Fail*	OUT: control (E-508.00: BNC+Offset / E-508.OE: SMB)
4	IN: control	OUT: monitor of piezo voltage (PZT $\div 1000$)
6	nc	nc
8	nc	nc
10	nc	nc
12	nc	nc
14	internal use (Bus_A)*	internal use (Bus_B)*
16	internal use (Bus_Vcc)*	internal use (Bus_GND)*
18	nc	nc
20	nc	nc
22	GND (measurement)	GND (measurement)
24	GND	GND
26	IN: +24 V to +27 V	IN: +24 V to +27 V
28	nc	nc
30	nc	nc
32	Protective earth (chassis)	Protective earth (chassis)

* no connection on E-508.OE

5.7.6. E-508.00 Gain Polarity and Output Range Settings

NOTICE



Damage from electrostatics!

The E-500/E-501 system contains electrostatic sensitive devices (ESD) and can be damaged if handled improperly.

- Avoid touching components, pins and PCB tracks.
- Before touching an electronic component, discharge yourself of any electric charges:
 - While working, wear an antistatic wrist strap or
 - Briefly touch a conducting, grounded object.

Making the gain polarity switch and output range jumper accessible

Only remove modules from the chassis when you are authorized and have the corresponding qualifications.

1. Remove the E-500/E-501 system from the power source by pulling the power plug.
2. Wait a minute to be sure that any residual voltage has dissipated.
3. Remove the E-508.00 module from the chassis:
 - a) Loosen the four Phillips screws on the front panel.
 - b) Using the grip at the bottom of the front panel, pull the module out of the chassis.
4. To access settings for gain polarity and output range, remove the rear cover plate from the E-508.00 module and slide back the perforated aluminum top.

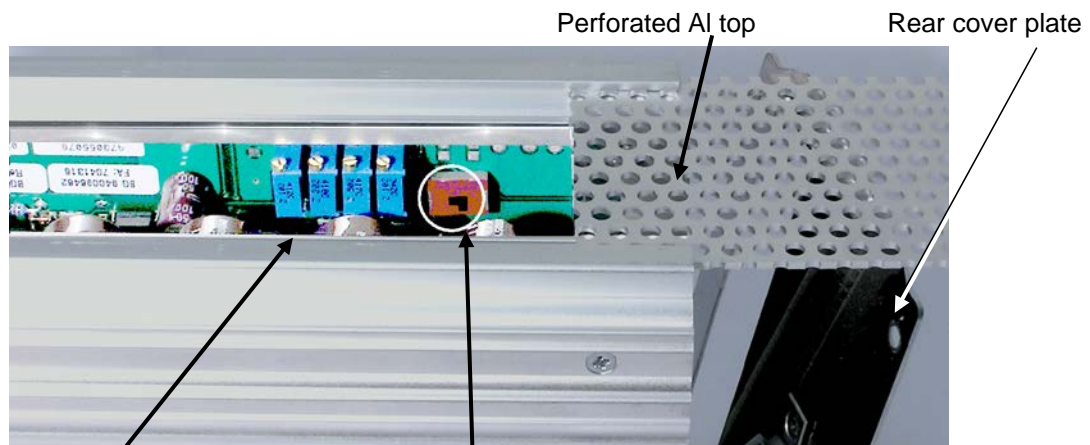

Trim Pots: DO NOT TOUCH

Gain polarity switch

Left:
gain = -100

Right (default):
gain = +100

Setting the Gain Polarity Switch

It is important to understand the relation between gain and the Control In range.

With DC-offset = 0 (full CCW), the Control In range is equal to output range (as set below) divided by the gain.

For example, in open-loop operation, the output range +3 to +1100 V and gain +100 yield a Control In range of 0 to +11 V.

Setting the Output Range Jumper

	<table border="1"> <thead> <tr> <th colspan="2">Ranges</th> </tr> </thead> <tbody> <tr> <td>E</td> <td>+3 to +1100 V (factory setting)</td> </tr> <tr> <td>D</td> <td>-260 to +780 V</td> </tr> <tr> <td>C</td> <td>-550 to +550 V</td> </tr> <tr> <td>B</td> <td>-780 to +260 V</td> </tr> <tr> <td>A</td> <td>-1100 to -3 V</td> </tr> <tr> <td colspan="2">To change setting, remove red cap (shown in Range E position) and replace over pins corresponding to desired range.</td> </tr> </tbody> </table>	Ranges		E	+3 to +1100 V (factory setting)	D	-260 to +780 V	C	-550 to +550 V	B	-780 to +260 V	A	-1100 to -3 V	To change setting, remove red cap (shown in Range E position) and replace over pins corresponding to desired range.	
Ranges															
E	+3 to +1100 V (factory setting)														
D	-260 to +780 V														
C	-550 to +550 V														
B	-780 to +260 V														
A	-1100 to -3 V														
To change setting, remove red cap (shown in Range E position) and replace over pins corresponding to desired range.															

5.8. E-509 Signal Conditioner / Servo-Controller Module

INFORMATION

- See the E-509 User Manual (PZ77) for a detailed description.
- See also the User Manuals for the E-802 servo-controller submodule (with all E-509 versions) and the E-801 sensor submodule (only with LVDT and strain gauge sensor versions).

5.8.1. Front Panel Elements of Modules for Dual-Electrode Capacitive Sensors



Fig. 19: E-509.C1A sensor / servo controller



Fig. 20: E-509.C2A sensor / servo controller



Fig. 21: E-509.C3A sensor / servo controller

Labeling	Type	Function
T	LEMO EPL.00.250.NTD	Input for the Target sensor signal from the piezo stage.
P	LEMO EPL.00.250.NTD	Input for the Probe sensor signal from the piezo stage.
ZERO	Trim potentiometer	A trimmer adjustment tool can be used on the ZERO potentiometer for a zero-point adjustment of the sensor. A zero-point adjustment can be necessary after longer operation (changes in temperature) or if the load on the piezo stage is changed.
OFL	LED Yellow/off	Overflow state: <ul style="list-style-type: none"> ▪ Yellow: Overflow condition, i.e. the amplifier is near its range limit. ▪ Off: No overflow condition When the OFL LED comes on, a zero-point adjustment of the sensor can be necessary. See p. 17 and the E-509 User Manual (PZ77E) for details.

Labeling	Type	Function
SERVO x ON/OFF x stands for the channel number	Toggle switch	Switch for the servo mode selection of the corresponding channel: <ul style="list-style-type: none"> ▪ ON: Servo mode is switched on (closed-loop operation) ▪ OFF: Servo mode is switched off (open-loop operation) See also “Starting Operation” on p. 17.
SENSOR MONITOR	LEMO EGG.0B.306.CLL	Output of the monitor signal(s) for the sensor channel(s). Pinout on p. 48.

5.8.2. Front Panel Elements of Modules for PISeca Single-Electrode Capacitive Sensors



Fig. 22: E-509.E3 sensor / servo controller

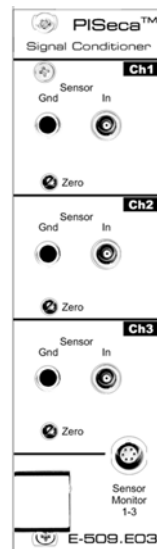

Fig. 23: E-509.E03 sensor signal conditioner

Labeling	Type	Function
Gnd	Banana socket	Ground connection for target plane of the PISeca single-electrode capacitive sensor.
In	LEMO ECP.00.650.NLL.543, triaxial	Input for the Probe sensor signal of the PISeca single-electrode capacitive sensor.
With E-509.E3 only: Servo x On/Off x stands for the channel number	Toggle switch	Switch for the servo mode selection of the corresponding channel: <ul style="list-style-type: none"> ▪ ON: Servo mode is switched on (closed-loop operation) ▪ OFF: Servo mode is switched off (open-loop operation) See also “Starting Operation” on p. 17.

Labeling	Type	Function
With E-509.E3 ony: OFL	LED Yellow/off	Overflow state: <ul style="list-style-type: none"> Yellow: Overflow condition, i.e. the amplifier is near its range limit. Off: No overflow condition When the OFL LED comes on, a zero-point adjustment of the sensor can be necessary. See p. 17 and the E-509 User Manual (PZ77E) for details.
ZERO	Trim potentiometer	A trimmer adjustment tool can be used on the ZERO potentiometer for a zero-point adjustment of the sensor. A zero-point adjustment can be necessary after longer operation (changes in temperature) or if the load on the piezo stage is changed.
SENSOR MONITOR	LEMO EGG.0B.306.CLL	Output of the monitor signals for the sensor channels. Pinout on p. 48.

5.8.3. Front Panel Elements of Modules for Strain Gauge Sensors



Fig. 24: E-509.S1 sensor / servo controller



Fig. 25: E-509.S3 and E-509.S31 sensor / servo controller

INFORMATION

In the labeling of E-509.S1 and E-509.S3 modules, X stands for S.

INFORMATION

E-509.S31 and E-509.S3N models for use with P-611 NanoCube® stages:

E-509.S31 differs from E-509.S3 only in the settings of the internal E-801 sensor submodule.

E-509.S3N consists of an E-509.S31 module plus a P-611.91 3-channel adapter cable LEMO/Sub-D 25 (f).

Labeling	Type	Function
OFL	LED Yellow/off	Overflow state: <ul style="list-style-type: none"> Yellow: Overflow condition, i.e. the amplifier is near its range limit. Off: No overflow condition When the OFL LED comes on, a zero-point adjustment of the sensor can be necessary. See p. 17 and the E-509 User Manual (PZ77E) for details.
SERVO ON/OFF 1, 2 and 3 stand for the channel numbers	Toggle switch	Switch for the servo mode selection of the corresponding channel: <ul style="list-style-type: none"> ON: Servo mode is switched on (closed-loop operation) OFF: Servo mode is switched off (open-loop operation) See also "Starting Operation" on p. 17.
ZERO	Trim potentiometer	A trimmer adjustment tool can be used on the ZERO potentiometer for a zero-point adjustment of the sensor. A zero-point adjustment can be necessary after longer operation (changes in temperature) or if the load on the piezo stage is changed.
SENSOR	LEMO ERA.0S.304.CLL	Input for the signals of the strain gauge sensor of the piezo stage. Pin assignment on p. 47.
SENSOR MONITOR	E-509.S1: BNC E-509.S3: LEMO ERA.0S.303.CLL	Output of the monitor signal(s) for the sensor channel(s). Pin assignment for E-509.S3 on p. 48.

5.8.4. Specifications

	E-509.C1A / E-509.C2A / E-509.C3A	E-509.S1 / E-509.S3 / E-509.S31
Function	Signal conditioner and servo-controller for piezo mechanics	Signal conditioner and servo-controller for piezo mechanics
Channels	1 / 2 / 3	1 / 3
Sensor		
Servo characteristics	Analog proportional-integral (P-I) algorithm with notch filter	Analog proportional-integral (P-I) algorithm with notch filter
Sensor type	2-plate capacitive	SGS
Sensor channels	1 / 2 / 3	1 / 3
Sensor bandwidth	0.3 to 3 kHz (adjustable with jumper); up to 10 kHz on request	0.3; 1; 3 kHz
Noise factor	0.115 ppm/Hz ^{1/2}	-
Thermal drift	< 0.3 mV/C°	< 3 mV /C°
Linearity	<0.05%	<0.2%
Linearization	ILS (Integrated Linearization System)	On E-801 submodule

	E-509.C1A / E-509.C2A / E-509.C3A	E-509.S1 / E-509.S3 / E-509.S31
Interfaces and operation		
Sensor connection	LEMO EPL.00.250.NTD	LEMO ERA.0S.304.CLL
Sensor monitor output	0 to 10 V (± 5 V)	0 to 10 V (± 5 V)
Sensor monitor socket	LEMO 6-pin FGG.0B.306.CLAD56	BNC (1-ch.) / 3-pin. LEMO ERA.0S.303.CLL (3-ch.)
Display	Overflow LED	Overflow LED
Miscellaneous		
Operating temperature range	+5 to +50°C	+5 to +50°C
Dimensions	7HP/3U	7HP/3U
Mass	0.2 kg / 0.25 kg / 0.35 kg	0.2 kg / 0.25 kg / 0.35 kg
Operating voltage	E-500/E-501 system, ± 15 V/0.5 A	E-500/E-501 system, ± 15 V/0.5 A
Max. power consumption	4 to 8 W	4 to 8 W

	E-509.E03	E-509.E3
Function	Signal conditioner electronics for PISeca sensors	Sensor / Piezo Servo-Control Module for PISeca sensors
Channels	3	3
Sensor		
Servo characteristics	-	Analog proportional-integral (P-I) algorithm with notch filter
Sensor type	PISeca single-electrode, capacitive	PISeca single-electrode, capacitive
Sensor bandwidth	3 kHz 0.3 / 10 kHz (selectable)	3 kHz 0.3 / 10 kHz (selectable)
Measurement range extension factors*	2 / 2.5 / 5 (option)	2 / 2.5 / 5 (option)
Synchronization	3 synchronized channels	3 synchronized channels
Electrical properties		
Output voltage	0 to 10 V -5 to +5 V, -10 to 0 V (selectable)	0 to 10 V
Thermal drift	<1 mV / C°	<1 mV / C°
Resolution @ 300 Hz (RMS)	<0.001% of measurement range	<0.001% of measurement range
Resolution @ 3 kHz (RMS)	<0.0025% of measurement range	<0.0025% of measurement range
Linearity @ nominal range	<0.1 % (<0.2% for D-510.020)	<0.1 % (<0.2% for D-510.020)
Interfaces and operation		
Sensor connection	3 × LEMO ECP.00.650.NLL.543 socket, triaxial	3 × LEMO ECP.00.650.NLL.543 socket, triaxial
Sensor monitor	0 to 10 V (± 5 V)	0 to 10 V (± 5 V)
Sensor monitor socket	LEMO 6-pin FGG.0B.306.CLAD56	LEMO 6-pin FGG.0B.306.CLAD56
Display	—	3 × Overflow LED
Supported functionality	ILS (Integrated Linearization System)	ILS (Integrated Linearization System)

	E-509.E03	E-509.E3
Miscellaneous		
Operating temperature range	+5°C to +40 °C	+5°C to +40 °C
Dimensions	7HP/3U	7HP/3U
Target ground connector	3 × banana socket	3 × banana socket
Operating voltage	E-500/E-501 system	E-500/E-501 system

*Extension factors to multiply by the nominal measurement range of the selected sensor head D-510, to be specified with order

5.8.5. Pin Assignment

SENSOR socket of E-509.S3 and E-509.S1

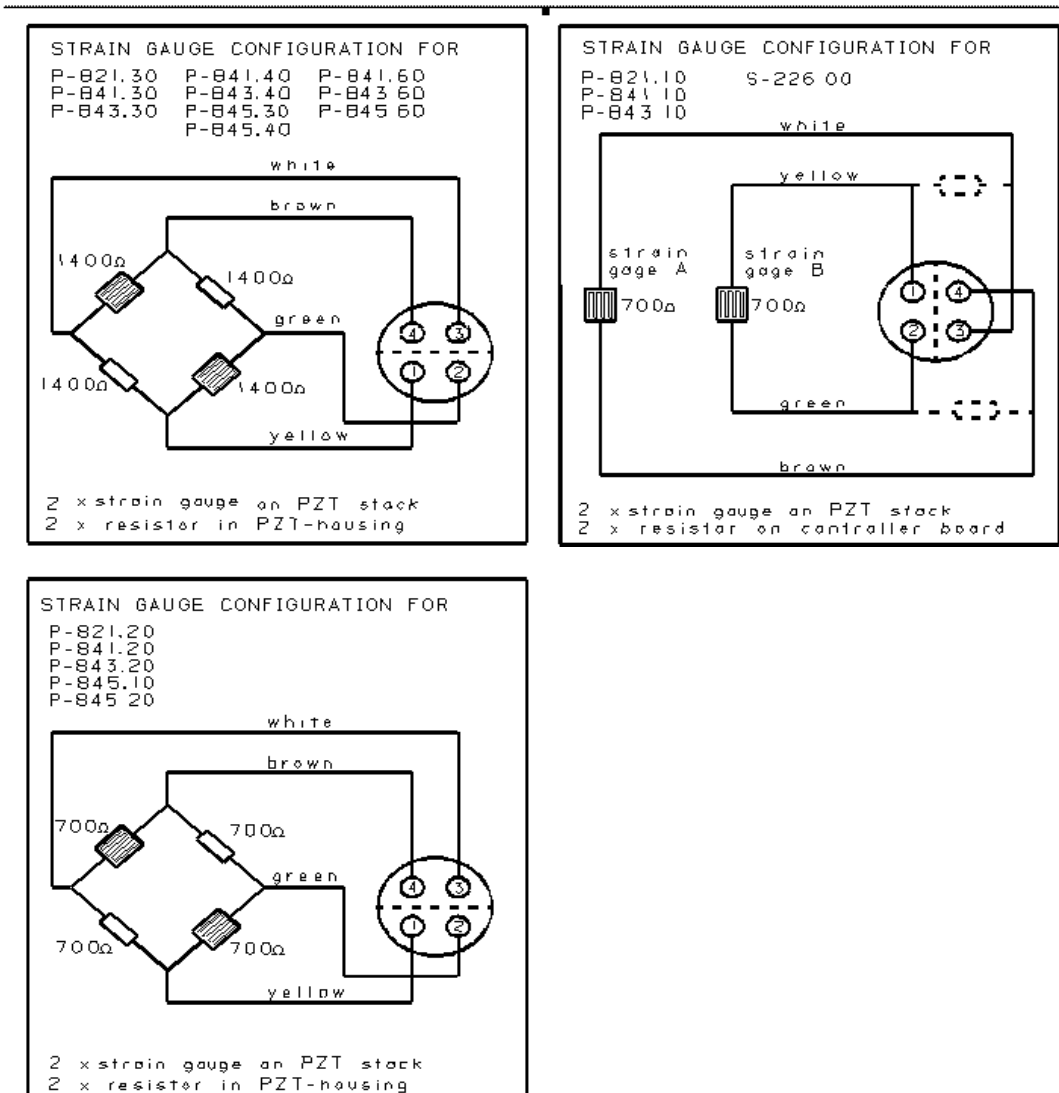

Fig. 26: Strain gauge sensor wiring for various piezo actuators

SENSOR MONITOR socket of E-509.S3

LEMO socket ERA.0S.303.CLL

The SENSOR MONITOR socket carries the signals from all three channels.

Each E-509.S3 comes with the E-808.90 sensor-monitor cable. The purpose of this cable is simply to split up the signals of the SENSOR MONITOR socket for the three channels.

The leads of this open-ended cable are color coded:
 white = channel 1,
 brown = channel 2,
 green = channel 3,
 shield = GND.

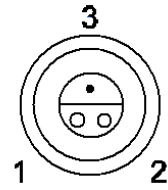

Fig. 27: Three-pin LEMO sensor monitor socket

SENSOR MONITOR socket of E-509.CxA and E-509.Ex

LEMO socket (FGG.0B.306.CLAD56), 6-pin

- pin 1 ch1+
- pin 2 ch1-
- pin 3 ch2+
- pin 4 ch2-
- pin 5 ch3+
- pin 6 ch3-
- shield: GND

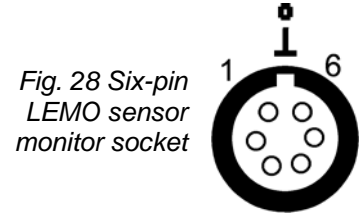

Fig. 28 Six-pin LEMO sensor monitor socket

Each capacitive sensor version comes with the D-893.32 sensor monitor cable (2 m). The purpose of this cable is simply to split up the signals of the SENSOR MONITOR socket onto three separate BNC connectors. The BNC connectors are each labeled with the channel number.

E-509.S3 32-pin connector, DIN 41612, male

Pin No.	Function	Pin No.	Function
2a	GND	2c	GND
4a	internal use	4c	OUT: ch1 (control)
6a	IN: +15 V	6c	IN: +15 V
8a	IN: -15 V	8c	IN: -15 V
10a	internal use*	10c	internal use
12a	internal use (Bus_A)	12c	OUT: ch2 (control)
14a	OUT: Display ch2	14c	OUT: Display ch1
16a	internal use (Bus_B)	16c	OUT: Display ch3
18a	internal use (BUS_Vcc)	18c	internal use (BUS_GND)
20a	IN: Control ch1	20c	OUT: ch3 (control)
22a	IN: Control ch3*	22c	IN: Control ch2
24a	internal use	24c	internal use
26a	IN: VC/EC ch2	26c	IN: VC/EC ch1
28a	OUT: Overflow ch1	28c	IN: VC/EC ch3*
30a	OUT: Overflow ch3	30c	OUT: Overflow ch2
32a	nc	32c	nc

Note: Pins labeled with "nc" may be used internally and must not be connected externally.

E-509.S1 32-pin connector, DIN 41612, male

Pin No.	Function	Pin No.	Function
2a	GND	2c	GND
4a	internal use	4c	OUT: ch1 (control)
6a	IN: +15 V	6c	IN: +15 V
8a	IN: -15 V	8c	IN: -15 V
10a	internal use	10c	internal use
12a	internal use (Bus_A)	12c	nc
14a	nc	14c	OUT: Display ch1
16a	internal use (Bus_B)	16c	nc
18a	internal use (BUS_Vcc)	18c	internal use (BUS_GND)
20a	IN: Control ch1	20c	nc
22a	nc	22c	nc
24a	internal use	24c	internal use
26a	nc	26c	IN: VC/EC ch1
28a	OUT: Overflow ch1	28c	nc
30a	nc	30c	nc
32a	nc	32c	nc

Note: Pins labeled with "nc" may be used internally and must not be connected externally.

E-509.C1A, E-509.C2A, E-509.C3A, E-509.E3, E-509.E03**32-pin connector, DIN 41612, male**

Pin No.	Function on			Pin No.	Function on		
	.C3A, .Ex**	.C2A	.C1A		.C3A, Ex**	.C2A	.C1A
2a	GND	*	*	2c	GND	*	*
4a	n.c.	*	*	4c	Control signal output CH1	*	*
6a	+ 15 V	*	*	6c	+ 15 V	*	*
8a	- 15 V	*	*	8c	- 15 V	*	*
10a	n.c.	*	*	10c	n.c.	*	*
12a	internal use	*	*	12c	Control signal output CH2	*	n.c.
14a	Display CH2	*	n.c.	14c	Display CH1	*	*
16a	internal use	*	n.c.	16c	Display CH3	n.c.	n.c.
18a	internal use	n.c.	n.c.	18c	internal use	*	*
20a	Control signal input CH1	*	*	20c	Control signal output CH3	to JP210, pin 1	n.c.
22a	Control signal input CH3	to JP210, pin 2	n.c.	22c	Control signal input CH2	*	n.c.
24a	n.c.	*	*	24c	SYNC	*	*
26a	Servo ON/OFF, ch2	*	n.c.	26c	Servo ON/OFF, ch1	*	*
28a	overflow CH1	*	*	28c	Servo ON/OFF, ch3	n.c.	n.c.
30a	overflow CH3	n.c.	n.c.	30c	overflow CH2	*	n.c.
32a	n.c.	*	*	32c	n.c.	*	*

* Same as on E-509.C3A

** E-509.E03 has no servo-controller and hence all servo-related pins are not connected

n.c. : No Connection: may be used on the backplane and must not be connected.

JP210 shorted on E-509.C2A (default): connects CH3 input to CH3 output (i.e. CH3 bypassed)

5.9. E-515 Display Modules

5.9.1. Front Panel Elements

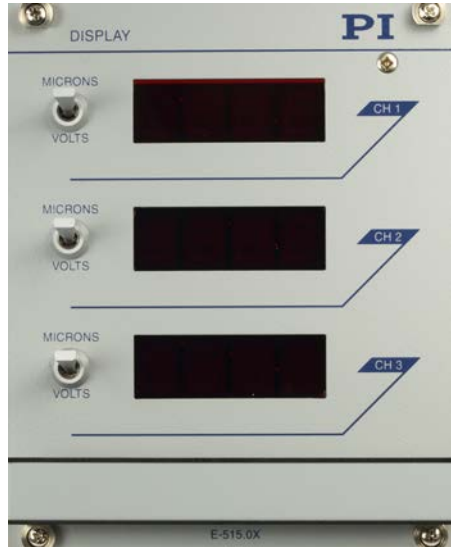

Fig. 29: E-515.03 display module

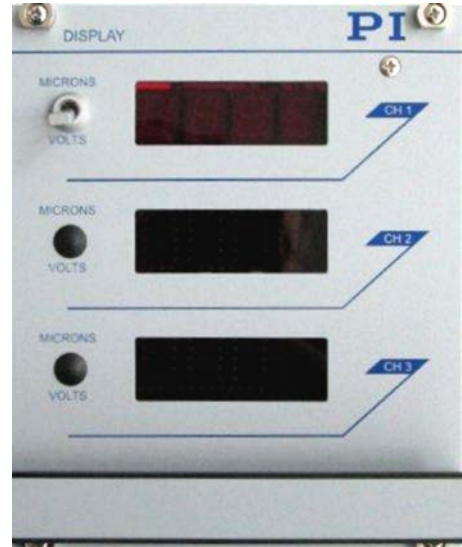

Fig. 30: E-515.01 display module

INFORMATION

In the labeling of E-515.01 and E-515.03 display modules, X stands for the supported number of channels.

Labeling	Type	Function
MICRONS / VOLTS	Toggle switch	Switch for selection of the signal to be displayed for the channel: <ul style="list-style-type: none"> ▪ MICRONS: Position (displacement) measured by the sensor ▪ VOLTS: Piezo voltage as output by the amplifier
-	Display with 3 ½ digits	If adjustment of the display should be necessary, see p. 52.

5.9.2. Specifications

Model	E-515.01	E-515.03
Function	Display Module for Piezo Voltage and Position	Display Module for Piezo Voltage and Position
Channels	1	3
Display linearity	0.1%	0.1%
Display	1 x 3½ digits	3 x 3½ digits
Dimensions	21HP/3U	21HP/3U
Mass	0.3 kg	0.3 kg
Operating voltage	E-500/E-501 system	E-500/E-501 system
Operating temperature	+5°C to +50°C	+5°C to +50°C

5.9.3. Pin Assignment

E-515.01 and E-515.03 32-pin connector, DIN 41612, male

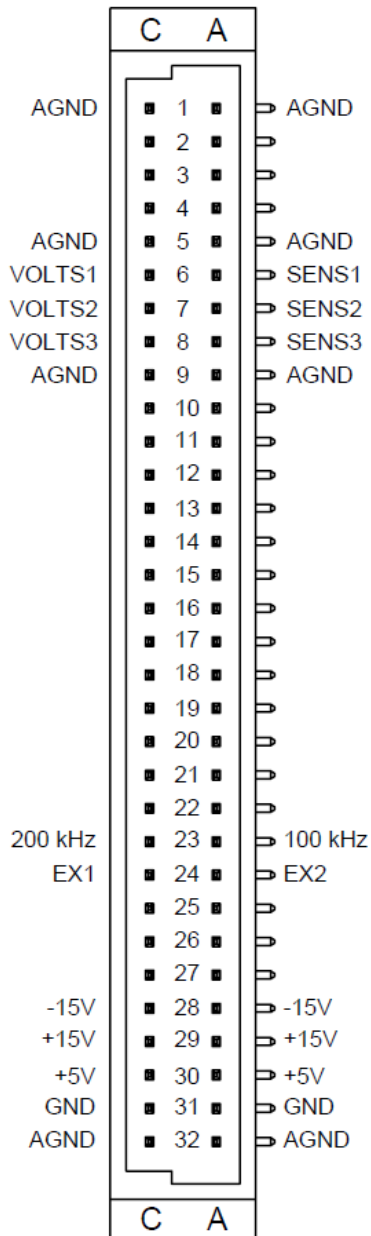

5.9.4. Display Adjustment

NOTICE



Damage from electrostatics!

The E-500/E-501 system contains electrostatic sensitive devices (ESD) and can be damaged if handled improperly.

- Avoid touching components, pins and PCB tracks.
- Before touching an electronic component, discharge yourself of any electric charges:
 - While working, wear an antistatic wrist strap
or
 - Briefly touch a conducting, grounded object.

INFORMATION

If ordered as part of a E-500/E-501 system or if PI is informed about the application, E-515.01 and E-515.03 display modules come preset (range, decimal places).

Making the display adjustment elements accessible

Only remove modules from the chassis when you are authorized and have the corresponding qualifications.

1. Remove the E-500/E-501 system from the power source by pulling the power plug.
2. Wait a minute to be sure that any residual voltage has dissipated.
3. Remove the E-515 module from the chassis:
 - a) Loosen the four Phillips screws on the front panel.
 - b) Using the grip at the bottom of the front panel, pull the module out of the chassis.

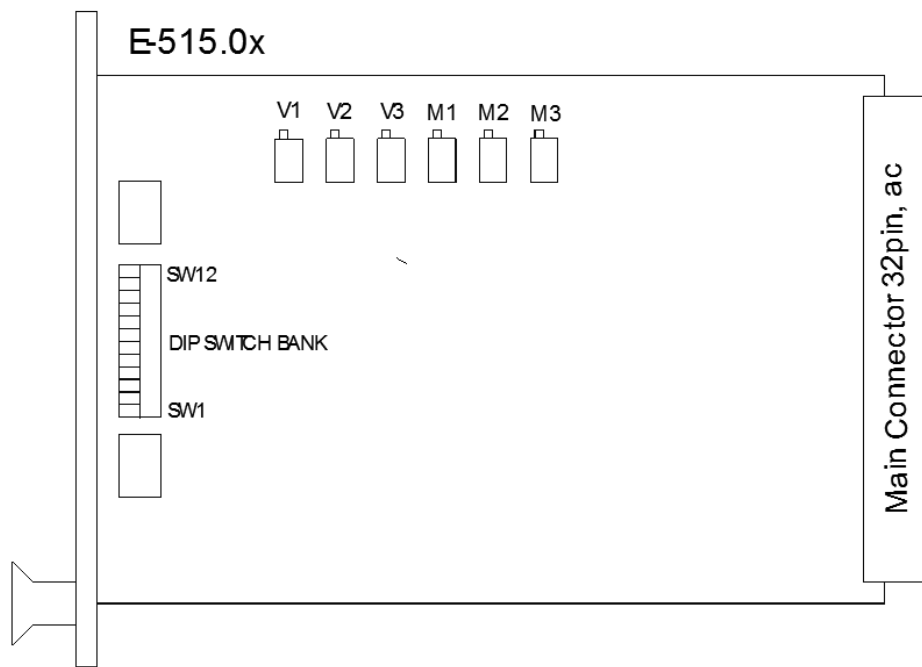

Fig. 31: Location of display adjustment elements on the E-515.0x display module

Potentiometers:

Reading adjustments:

V1–V3:	Voltage channels 1–3
M1–M3	Microns channels 1–3

DIP Switch Settings

Setting the decimal point:

S1–S3:	Micron channel 3
S4:	Volt channel 3
S5–S7:	Micron channel 2
S8:	Volt channel 2
S9–S11:	Micron channel 1
S12:	Volt channel 1

5.10. E-517 Computer Interface and Display Module

INFORMATION

➤ See the E-517 User Manual (PZ214E) for a detailed description.

5.10.1. Front Panel Elements

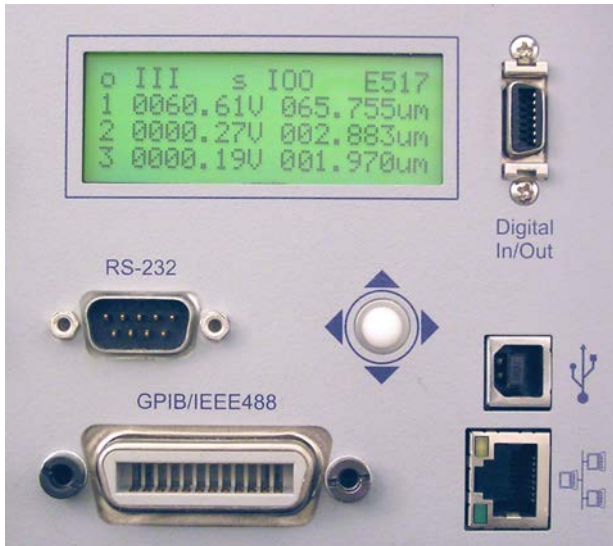
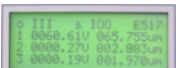





Fig. 32: E-517.i3 interface / display module, single-channel E-517.i1 models have identical front panels but show only one channel in the display



Fig. 33: E-517.i30 interface / display module, single-channel E-517.i10 models have identical front panels but show only one channel in the display

Labeling	Type	Function
	LCD display	See "Display Screens" in the E-517 user manual for details.
Digital In/Out	MDR14 socket	Digital input and output lines; can be used to trigger external devices and to send start and synch. signals to the wave generator(s). See "Digital In/Out Socket" in the E-517 user manual for the availability of the lines and for pinout.
RS-232	Sub-D 9-pin panel plug, male	Serial connection to host PC. See "RS-232 Socket" in the E-517 user manual for pinout.
	Trackball	Display selection, device configuration and triggering of ONLINE motion. See "Trackball Functions" in the E-517 user manual for details.
	USB-B socket	Universal Serial Bus for connection to host PC. See "USB Connection" in the E-517 user manual for more information.
E-517.i3 and E-517.i1 only: GPIB/IEEE488	IEEE-488 micro ribbon socket	General Purpose Interface Bus (GPIB) for connection to host PC. See "GPIB Connection" in the E-517 user manual for more information.
	RJ45 socket	Network connection over TCP/IP. See "TCP/IP Connection" in the E-517 user manual for more information.

5.10.2. Specifications

	E-517.i1, E-517.i10	E-517.i3, E-517.i30
Function	Digital operation module	Digital operation module
Channels	1	3
Processor	DSP 60 MHz	DSP 60 MHz
Sampling rate, sensor	25 kHz, 8-times oversampling	25 kHz, 8-times oversampling
Thermal drift	Stability: 0.2 mV	Stability: 0.2 mV
Linearity @ nominal range	0.01%	0.01%
Resolution	DAC: 24 bit, ± 12 V ADC: 18 bit, sampling	DAC: 24 bit, ± 12 V ADC: 18 bit, sampling
Interfaces and operation		
Interfaces/communication	Ethernet (TCP/IP), USB, RS-232, IEEE 488 (E-517.i1 only)	Ethernet (TCP/IP), USB, RS-232, IEEE 488 (E-517.i3 only)
I/O ports	1 trigger input 1 trigger output 5 V MDR14 connector	3 trigger inputs 3 trigger outputs 5 V MDR14 connector
Command set	PI General Command Set (GCS)	PI General Command Set (GCS)
User software	PIMikroMove	PIMikroMove
Software drivers	Lab VIEW drivers, Windows and Linux Libraries (DLL)	Lab VIEW drivers, Windows and Linux Libraries (DLL)
Supported functionality	Wave generator, data recorder, macro programming	Wave generator, data recorder, macro programming
Display	LCD display for monitor signals (position and voltage), states and trackball menus	LCD display for monitor signals (position and voltage), states and trackball menus
Manual control	Operation via trackball	Operation via trackball
Miscellaneous		
Operating temperature range	+5° to +50° C	+5° to +50° C
Dimensions	21HP/3U	21HP/3U
Mass	0.37 kg	0.37 kg
Operating voltage	E-500/E-501 system; +5 V, 1 A ± 15 V, 0.5 A	E-500/E-501 system; +5 V, 1 A ± 15 V, 0.5 A

5.10.3. Pin Assignment**32-pin connector, DIN 41612, male**

Row	Pin a	Pin c
1	AGND	AGND
2	IN: ch1	OUT: ch1
3	IN: ch2	OUT: ch2
4	IN: ch3	OUT: ch3
5	AGND (analog)	AGND (analog)
6	IN: Sensor Monitor ch1	IN: PZT Monitor ch1
7	IN: Sensor Monitor ch2*	IN: PZT Monitor ch2*
8	IN: Sensor Monitor ch3*	IN: PZT Monitor ch3*
9	AGND (analog)	AGND (analog)
10	nc	nc
11	I ² C SCL	I ² C SDA
12	nc	nc
13	VC/EC ch1 (servo mode)	Overflow ch1
14	VC/EC ch2* (servo mode)	Overflow ch2*
15	VC/EC ch3* (servo mode)	Overflow ch3*
16	On Target ch1	nc
17	On Target ch2*	nc
18	On Target ch3*	nc
19	nc	nc
20	nc	nc
21	nc	nc
22	nc	nc
23	Sync_100k	Sync_200k
24	nc	nc
25	nc	nc
26	nc	nc
27	nc	nc
28	-15 V	-15 V
29	+15 V	+15 V
30	+5 V (VCC)	+5 V (VCC)
31	GND (VCC)	GND (VCC)
32	AGND (analog)	AGND (analog)

nc - no connection

AGND - Analog Ground, isolated from the GND (VCC) (pins 31ac)

* on E-517.i1 and E-517.i10, lines for channels 2 and 3 should not be used

5.11. Dummy Modules

Your E-500/E-501 system may be equipped with one or more dummy modules:

E-595.00 Replaces E-509.xx sensor modules (all types)

E-596.00 Replaces the E-517 interface / display module (or the E-515 display module), if E-509 modules for SGS sensors are installed

E-596.10 Replaces the E-517 interface / display module (or the E-515 display module), if E-509 modules for capacitive sensors are installed

The purpose of these dummies is to complete the internal circuitry and the front panel of the chassis.

INFORMATION

Your E-500/E-501 system may be equipped with one or more dummy modules. Do not operate your E-500/E-501 system when (dummy) modules are removed. Without the dummy module(s), the system will malfunction because no Control In signal can be feed into the amplifier module due to the broken circuit.

6. Integrating Modules in Third-Party Systems

6.1.1. Safety Measures for Integration in Third-Party Systems

DANGER



High Voltage!

- Only authorized and qualified personnel must install, operate, maintain and clean the modules of the E-500/E-501 series.
- Remove the third-party system from the power source before integrating modules of the E-500/E-501 series.

The amplifier modules of the E-500/E-501 series output up to 130 V (E-503, E-504, E-505, E-506) or up to 1100 V (E-508). Touching this High Voltage can result in serious or even lethal injury due to electric shock.

- Operate an amplifier module only when it is installed in a suitable chassis and connected to a protective earth conductor via pins 32a and 32c of the 32-pin connector, DIN 41612, male.
 - Make sure that the resistance of the protective earth conductor is $< 1 \Omega$ at 25 A on all interfaces relevant for the function of the protective earth conductor.
 - If the protective earth conductor has to be removed (e.g. in case of system modifications), reconnect the protective earth conductor before the next start-up of the module.
- When you operate E-504, E-505 or E-506 amplifier modules, do not touch pins 6a, 6c, 8a and 8c of the 32-pin connector since the piezo voltage is output on these pins (in addition to the output on the **PZT** socket of the front panel).

NOTICE



Damage from electrostatics!

The E-500/E-501 system contains electrostatic sensitive devices (ESD) and can be damaged if handled improperly. When operated without chassis, the modules of the E-500/E-501 system can emit electrical, magnetic or electromagnetic fields which interfere with the environment.

- Avoid touching components, pins and PCB tracks.
- Before touching an electronic component, discharge yourself of any electric charges:
 - While working, wear an antistatic wrist strap
or
 - Briefly touch a conducting, grounded object.
- When modules of the E-500/E-501 series are installed in a third-party chassis, make sure that the system complies with the EMC requirements.

6.1.2. Supply Power for the Modules

The supply power must be stable within a range of 2 % of the nominal value.

For stable supply power with dynamic operation of high piezo loads, the power supply must be equipped with a sufficiently dimensioned buffer capacitor. The required capacitance of the buffer can be approximated as follows:

Buffer capacitance = 10 × piezo load

6.1.3. Amplifier Modules: Closing the Circuit

In order to feed the Control In signal (DC-Offset potentiometer and/or Control Input) into the amplifier, short the following pins:

E-504, E-505, E-506, E-508 → pin 2c to 4a

E-503 → pin 2c to 4a; pin 10c to 12a; pin 18c to 20a

Otherwise the output voltage of the amplifier would go to its positive / negative limit.

7. Maintenance

7.1. Cleaning

NOTICE



Short circuits or flashovers!

The E-500/E-501 system contains electrostatic sensitive devices that can be damaged by short circuits or flashovers when cleaning fluids enter the case.

- Before cleaning, remove the E-500/E-501 system from the power source by pulling the power plug.
- Prevent cleaning fluid from entering the case.

The housing surfaces of the device can be cleaned using mild detergents or disinfectant solutions. Organic solvents must not be used.

7.2. AC Power and Line Fuses

DANGER



Risk of electric shock!

The E-500/E-501 system requires a supply voltage of 100 to 120 VAC or 220 to 240 VAC (line voltage). Touching the line voltage can result in serious or even lethal injury due to electric shock.

- Remove the power cord from the E-500/E-501 system before you change the line fuses.

INFORMATION

Both line fuses of the E-500/E-501 system are active.

- Check both fuses if there is a fault.

The power connection and line fuses are located on the rear panel of the chassis. To access the line fuses, proceed as follows:

- 1 Switch off the E-500/E-501 system and remove the power cord.
- 2 Wait a minute to be sure that any residual voltage has dissipated.
- 3 Pry open the door that covers the fuse carrier and pry out the fuse carrier (see figures below).

- 4 Be sure to replace both fuses with fuses of the suitable type:

Model	Line voltage ranges and fuse values	
E-500.00	100 to 240 V~ 2 x IEC T2AH, 250 V	
E-501.00	100 to 120 V~ 2 x IEC T2AH, 250 V	220 to 240 V~ 2 x IEC T1AL, 250 V
E-500Kxxx	see product-specific documentation or nameplate label on device	
E-501Kxxx	see product-specific documentation or nameplate label on device	

Note: IEC-standard fuses are designed to carry the nominal current indefinitely. Other fuse rating standards differ.

- 5 Reinstall the carrier and close the door



8. Customer Service

For inquiries and orders, contact your PI sales engineer or send us an e-mail (<mailto:info@pi.ws>).

If you have questions concerning your system, have the following information ready:

- Product codes and serial numbers of all products in the system
- Firmware version of the controller (if present)
- Version of the driver or the software (if present)
- Operating system on the PC (if present)

The latest versions of the relevant user manuals for your system are available for download on our website (www.pi.ws).

9. Old Equipment Disposal

In accordance with the applicable EU law, electrical and electronic equipment may not be disposed of with unsorted municipal wastes in the member states of the EU.

When disposing of your old equipment, observe the international, national and local rules and regulations.

To meet the manufacturer's product responsibility with regard to this product, Physik Instrumente (PI) GmbH & Co. KG ensures environmentally correct disposal of old PI equipment that was first put into circulation after 13 August 2005, free of charge.

If you have old PI equipment, you can send it postage-free to the following address:

Physik Instrumente (PI) GmbH & Co. KG

Auf der Römerstr. 1

D-76228 Karlsruhe, Germany

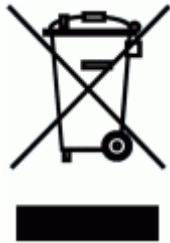

10. Appendix

10.1. Lifetime of PICMA® Actuators

The following factors which can have an impact on the actuator lifetime must be taken into consideration: Applied voltage, temperature and relative humidity.

The effect of each individual factor on the lifetime can be read off the diagrams shown below. The lifetime calculated in hours simply results as the product of all three values read off the diagrams.

The impact that the applied voltage has, is particularly important. With decreasing voltage the lifetime increases exponentially. This must always be taken into consideration in an application. The recommended maximum range of the control input voltage for the E-500/E-501 system therefore is -2 to 12 V, resulting in a piezo voltage range of -20 to 120 V. A control input range of -3 to 13 V is possible (results in -30 to 130 V piezo voltage), but will reduce the actuator lifetime accordingly.

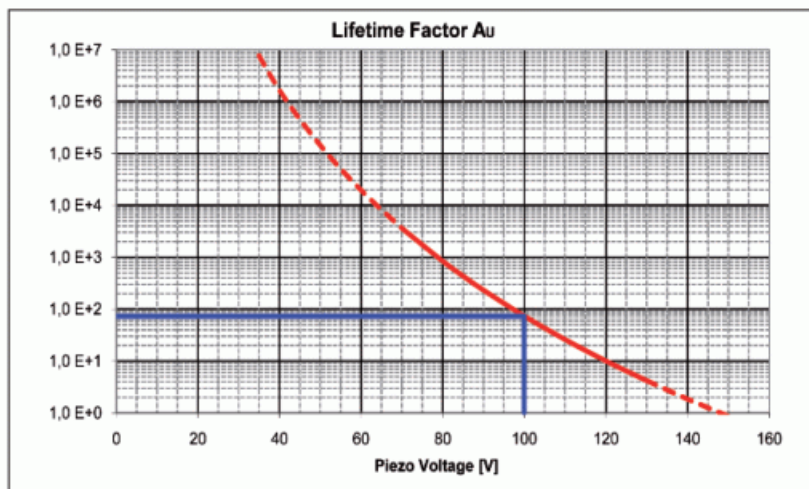

Fig. 34: Interdependency between the mean MTF of a PICMA® actuator and the value of the voltage applied

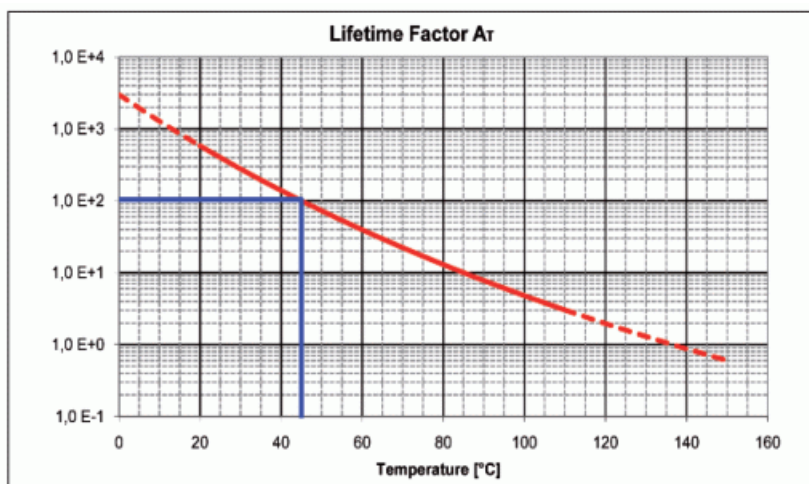

Fig. 35: Interdependency between the mean MTF of a PICMA® actuator and the ambient temperature

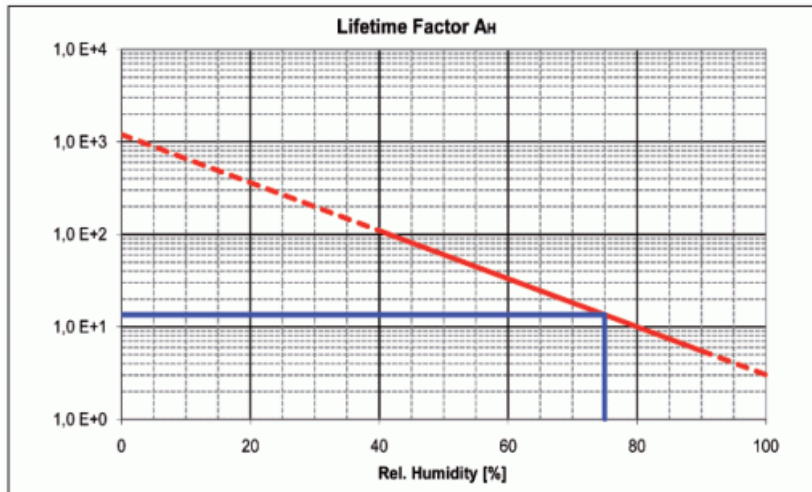

Fig. 36: Interdependency between the mean MTTF of a PICMA® actuator and the relative humidity

Example

The simple formula $MTTF = AU * AT * AF$ provides a quick estimate of the reliability in hours. In concrete terms: The values for 75% RH ($AF=14$), 100 VDC ($AU=75$) and 45 °C ($AT=100$) result in an approximate MTTF of 105,000 h, i.e. more than 11 years (see markings on the diagrams).

Read the “Tutorial: Piezoelectrics in Positioning” in the PI Catalog for detailed information.

10.2. How to Measure the Amplifier Output of E-504 Modules

The innovative, efficient circuitry of the E-504 amplifier module reduces power consumption and heat dissipation, especially in dynamic applications. Working with an internal switching frequency of 100 kHz, charge is transferred to the piezo actuator using low-loss PWM techniques. The ripple of the amplifier output is <100 mVpp at 100 kHz. But when measuring the amplifier output signal with low sampling rate and small bandwidth (e.g. with a digital oscilloscope), aliasing will occur and distort the measurement result. In digital signal processing, aliasing refers to an effect that the signal reconstructed from samples is different than the original continuous signal when the sampling rate is too low. With the E-504 amplifier output, this means that a low-frequency signal seems to be measured which is not present at all.

Example:

When a 91 Hz signal is sampled with 100 Hz sampling rate, the result seems to be a 9.1 Hz signal (see figure below).

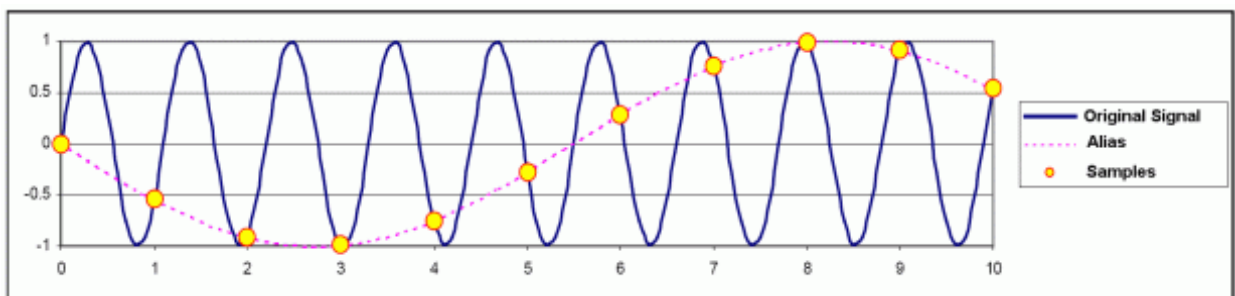

Fig. 37: Signal digitization with too low sample rate (time in 1/100 s): Original signal = 91 Hz and sampling rate = 100 Hz; the result is mistaken as a 9.1 Hz signal (“Alias”)

To avoid aliasing, the sampling rate must be at least twice as high as the highest frequency in the signal to be sampled (according to the Nyquist–Shannon sampling theorem). I.e. with

an amplifier switching frequency of 100 kHz, the sampling rate must be 200 kHz or higher. If the sampling rate provided by your oscilloscope is not high enough, use a low-pass filter at the oscilloscope input to eliminate frequencies above 100 kHz. Alternatively, you can use an analog oscilloscope or perform high-resolution measurements in the lower frequency range.

When following those instructions, you will obtain valid measurement results.

10.3. EC Declaration of Conformity

For the E-500/E-501, an EC declaration of conformity according to the following European directives was issued:

2006/95/EC, Low Voltage Directive (LVD)

2004/108/EC, EMC Directive

2011/65/EC, RoHS Directive

The applied standards certifying the conformity are listed below.

Electromagnetic Emission: EN 61000-6-3:2007, EN 55011:2009

Electromagnetic Immunity: EN 61000-6-1:2007

Safety (Low Voltage Directive): EN 61010-1:2010

If electrical equipment is intended to be integrated in other electrical equipment: The user is responsible for compliant connection of the electrical equipment when implementing the total system.

